

TABLE OF CONTENTS

Balustrade Parts Lists	32-34, 38
5", 6", 7" Balustrade System	35-37
12" Balustrade System	38-42
Brick and Masonry Applications	16
Crossheads for Doors and Windows	20
Decorative Millwork	25
Detailed Mouldings	23
Domes	28-29
Door Trim Kit	22
E-Vent System	18
Finishing Options	16
General Information	9
Glossary	43-46
Installing Irregular Shaped Trim	14
Limited Warranty	9
Louvers	17
Medallions, One-piece	26
Medallions, Two-piece	27
Miterless Crown Moulding System	24
New Construction	
Vinyl, Aluminum and Steel Sidings	12
Hardboard and Wood Sidings	13
Niches	30
Niche Assembly	31
Pilasters	19
Remodeling	
Vinyl, Aluminum and Steel Sidings	10
Hardboard and Wood Sidings	11
Structural Columns	43-44
Synthetic Stucco Applications	15
Window Trim Kit	21

GENERAL INFORMATION

Before installation, please keep in mind that Fypon products:

- Should be used for decorative purposes only, not to provide structural support (except Structural Columns, Balustrade Systems and Porch Posts).
- Should never be installed with mechanical fasteners only. For best results always use non-corrosive fasteners along with urethane base PL Premium Adhesive.
- Are easy to repair. Use wood filler or automotive filler to quickly fill dents or gashes of any size. Broken moulding can be successfully rejoined with urethane base PL Premium Adhesive.
- Should not be stored in extreme heat. Acclimate before installation. Due to urethane's high insulating value, this may take up to 10 hours.
- Will resist the elements, except for direct sunlight to the yellowish (unpainted) underside of the millwork. It is important to fill damaged or cut surfaces with putty, caulk, and/or paint within a few days.
- Can withstand temperatures of about 140°F (60°C). However, the millwork should never be placed in an area subject to solar temperature buildup, such as behind a storm door.
- Can be used safely in accordance with SBCCI, BOCA, CABO and NFPA rulings. There are no official independent laboratory fire test results for Fypon products. The products are equivalent to any decorative urethane products not specifically formulated for fire resistance.
- May require altered installation procedures to meet local specifications. Check local building codes.

The installation suggestions in this catalog are to be used only as a guideline. Fypon, Ltd. assumes no liability for any damages, including but not limited to personal, property, incidental, or consequential damages, resulting from the installation of its products. Fypon, Ltd.'s sole responsibility in connection with the sale and installation of its products is the limited warranty set forth below.

FYPON LIMITED WARRANTY

Fypon, Ltd. warrants to the original consumer purchaser that our exterior white primer paint finish will be free from UV ray degradation, blistering, and paint peeling under normal use for a period of one (1) year from the date of purchase.

We further provide a LIFETIME WARRANTY to the original purchaser on the urethane material. This LIFETIME WARRANTY provides that the urethane material will be free from defects in material and workmanship under normal use.

If a defect is found in a Fypon product and the above conditions have been met, a customer should notify Fypon in writing within thirty (30) days of discovering the defect. The customer may be required to return the product to Fypon (at his or her expense) for evaluation. Fypon will then review the situation and determine if replacement, repair or refund of the product is appropriate. This warranty does not include labor, transportation costs or any other expenses of any kind incurred in connection with the purchase, use or installation of the product. Replacement, repair or refund is the sole and exclusive option under this limited warranty.

This limited warranty does not cover damage resulting from mishandling in transit (if within the customer's control), acts of God, customer alteration, vandalism, misuse, abuse, improper maintenance, unreasonable care or other causes not arising from defects in workmanship and materials. THERE ARE NO WARRANTIES, EXPRESS OR IMPLIED, WRITTEN OR ORAL, INCLUDING ANY WARRANTIES OF MERCHANTABILITY OR FITNESS FOR PURPOSE, OTHER THAN AS EXPRESSED HEREIN. No person, agent, distributor, dealer, service facility, or company is authorized to change, modify or amend the terms of this limited warranty in any manner or fashion whatsoever, except to the extent provided in this limited warranty. Fypon, Ltd. shall not be liable to the customer or to any other person for any incidental or consequential damages or loss of profit resulting from any defect in the product.

Some states do not allow limitations on how long an implied warranty lasts, or the exclusion or limitation of incidental or consequential damages, so that the above limitation or exclusion may not apply. This warranty gives you specific legal rights. You may also have other rights which vary from state to state.

Remodeling - General Instructions

TECHNIQUES FOR VINYL, ALUMINUM AND STEEL SIDINGS

When remodeling, Fypon products can be installed over existing exterior siding. Always assess the wall area where the millwork will be positioned.

If there is solid sheathing or framing behind the siding, Fypon products should be secured to it. However, if solid material cannot be located, use hollow wall fasteners.

Millwork can be placed flush against existing brickmoulding. Apply PL Premium Adhesive along with noncorrosive fasteners to securely fasten to the sidewall surface.

Tip: We suggest using screws when securing millwork over siding. The extra holding strength of the screws along with PL Premium adhesive will secure millwork in place.

INFORMATION ABOUT VINYL SIDING

Fypon products may be fastened directly on top of existing vinyl siding. However, since vinyl siding expands and contracts with temperature changes, a few extra steps are necessary to prevent the vinyl siding from buckling behind the millwork.

1. Position the millwork, then drill several small pilot holes through the millwork into the vinyl siding.
2. Remove the millwork and enlarge the pilot holes in the vinyl siding to approximately three times the diameter of the screw. This provides room for siding to expand and contract.
3. Caulk the drilled holes in the siding to prevent moisture migration behind the vinyl siding.
4. Next, apply a good quality, flexible construction adhesive to the back of the millwork. This type of adhesive allows the vinyl siding to flex, yet bonds the millwork securely to the vinyl siding surface. We recommend a flexible construction adhesive for this application.
5. Reposition the millwork and screw into the center of each drilled hole. Fill countersunk fastener holes with plastic wood filler. Sand filled holes smooth and touch up with paint.

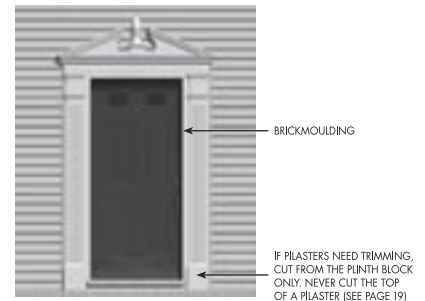
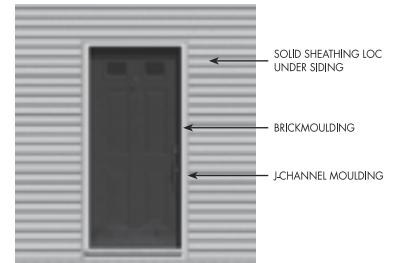

USING CORROSION-RESISTANT FASTENERS AND PL PREMIUM ADHESIVE

Always use corrosion-resistant mechanical fasteners (nails or screws) and PL Premium Adhesive when installing Fypon products. This combination provides a secure, long lasting bond. Countersink all fasteners about 1/8 inch and fill with exterior grade white spackle. If desired, sand any minor imperfections and topcoat with a quality exterior latex or oil base paint. Fypon exterior millwork installations should be finished using a quality, exterior grade silicone caulk to prevent water infiltration behind siding, windows and doors. Some exterior millwork installations, in particular new construction (before siding is applied) may require a J-channel and/or flashing to prevent water infiltration. Installers must determine which installation technique is best for the specific situation.

IMPORTANT:

Please read these installation guidelines thoroughly before beginning installation. Please note that these guidelines are provided only to assist with the installation of Fypon mouldings and millwork products. Modified procedures may be required in order to meet specific situations, unique applications and local building codes. The manufacturer does not under any circumstances warrant the installation of its products. Be sure to wear appropriate protective clothing, gloves and safety glasses when working with any tools. Installer should check for and relocate all electrical wiring within the proposed installation area, as needed (be sure to disconnect all electric power before working with any electrical wiring and follow all applicable local electrical codes and safety procedures).

Remodeling - General Instructions

TECHNIQUES FOR HARDBOARD AND WOOD SIDINGS

Fypon products may be installed directly over hardboard and wood siding.

PILASTERS

When installing Pilasters, measure the distance from the landing floor to the top of the brickmoulding. The Pilaster height should be cut at 3/16" longer than the top of the brickmoulding.

Apply PL Premium Adhesive around the top and side edges of the Pilasters. Do not apply adhesive to the bottom edge. The bottom edge should remain open to allow moisture to seep out. Next, position the Pilasters and fasten with noncorrosive fasteners.

TIP: We suggest using screws when securing the millwork over the siding. The extra holding strength of the screws along with the adhesive will secure the millwork in place.

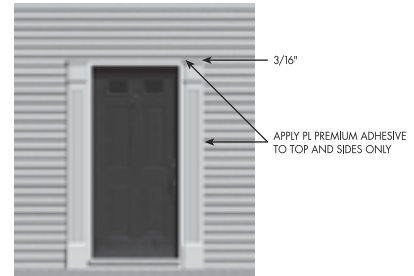

CROSSHEADS

1. When installing Crossheads, it is important to apply vertical strips of vinyl undersill finish trim to prevent moisture from collecting behind the millwork. Trapped water will deteriorate the surface of the wood or hardboard siding. Use PL Premium Adhesive and galvanized roofing nails to secure the undersill strips vertically every 16" - 24" to the back of the Crosshead.
2. To install a Crosshead, apply PL Premium Adhesive to the back of the vertical undersill strips.
3. Position the Crosshead directly above the Pilasters (which will also be 3/16" above the top of the brickmoulding to allow moisture to escape). Fasten Crosshead in place using PL Premium Adhesive and noncorrosive fasteners.
4. Countersink fasteners with a non-shrinking filler and allow to dry. Sand filled holes and touch up with paint.

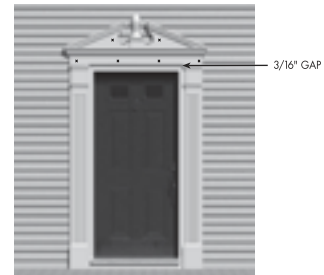
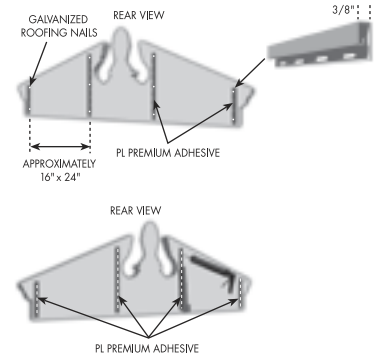

TIP: We suggest using screws when securing the Crosshead over hardboard siding materials. The extra holding strength of the screws along with the adhesive will secure the Crosshead in place.

USING CORROSION-RESISTANT FASTENERS AND PL PREMIUM ADHESIVE
 Always use corrosion-resistant mechanical fasteners (nails or screws) and PL Premium Adhesive when installing Fypon products. This combination provides a secure, long lasting bond. Countersink all fasteners about 1/8 inch and fill with exterior grade white spackle. If desired, sand any minor imperfections and topcoat with a quality exterior latex or oil base paint. Fypon exterior millwork installations should be finished using a quality, exterior grade silicone caulk to prevent water infiltration behind siding, windows and doors. Some exterior millwork installations, in particular new construction (before siding is applied) may require a J-channel and/or flashing to prevent water infiltration. Installers must determine which installation technique is best for the specific situation.

IMPORTANT:
 Please read these installation guidelines thoroughly before beginning installation. Please note that these guidelines are provided only to assist with the installation of Fypon mouldings and millwork products. Modified procedures may be required in order to meet specific situations, unique applications and local building codes. The manufacturer does not under any circumstances warrant the installation of its products. Be sure to wear appropriate protective clothing, gloves and safety glasses when working with any tools. Installer should check for and relocate all electrical wiring within the proposed installation area, as needed (be sure to disconnect all electric power before working with any electrical wiring and follow all applicable local electrical codes and safety procedures).

New Construction - General Instructions

TECHNIQUES FOR VINYL, ALUMINUM AND STEEL SIDINGS

- For a new construction exterior, always prepare the area so Fypon products can be fastened securely to the sidewall surface. Apply plywood or oriented strandboard (OSB) sheathing where the millwork will be installed.

1a. Apply a moisture-resistant house wrap material to the sheathing material as per the manufacturers recommendations before installing millwork.

- On the back of both Pilasters, apply a 1/4" bead of PL Premium Adhesive around the perimeter. Place Pilasters in position (right Pilaster on right side, etc.), aligning the edges of the Pilasters flush with the top and sides of the brickmoulding. Fasten millwork using PL Premium Adhesive and non-corrosive fasteners.

NOTE: If Pilasters need trimming, cut from the base only. Never cut the top of a Pilaster.

IMPORTANT: If a storm door is being installed — keep the brickmould in place and mount the storm door securely to the wooden brickmoulding. However, if desired and a storm door is not to be installed, the wooden brickmould material may be removed.

- After installing the Pilasters, if the pilasters are not routed, butt and fit the siding manufacturer's recommended J-channel mouldings to the sides of the Pilasters and the top of the doorway. Install siding into J-channels, completely surrounding the doorway.

NOTE: Try to avoid placing siding lap joints above the doorway where a Crosshead may be positioned. This will eliminate any chance of moisture collecting behind the Crosshead and migrating into the sheathing material behind the Crosshead.

- Due to the complexity of cutting and fitting flashing and siding to irregular shapes such as Crossheads, apply PL Premium Adhesive to the back of millwork, then position DIRECTLY OVER siding and securely fasten with noncorrosive fasteners. Any moisture that migrates behind the Crosshead will be flashed away by the J-channel trim installed in Step 3.

TIP: We suggest using screws when securing millwork OVER SIDING materials. The extra holding strength of the screws along with the PL Premium Adhesive will securely hold the Crosshead in place.

Important: When applying Crossheads over vinyl siding see information on Page 10, "Important Information About Vinyl Siding."

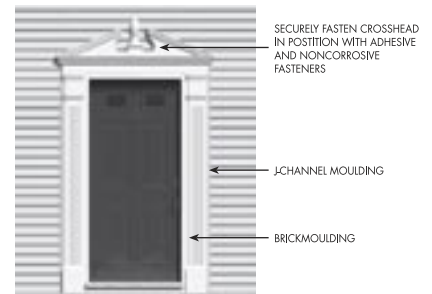
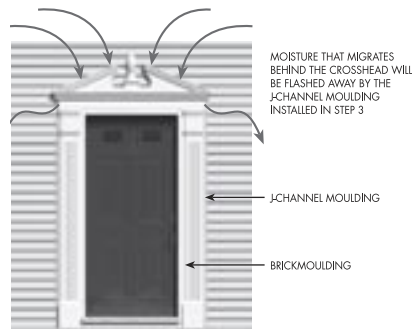
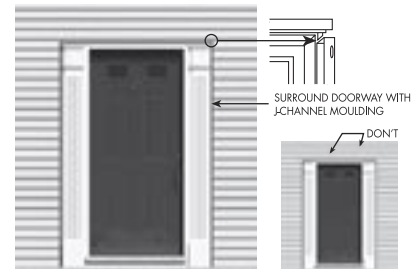
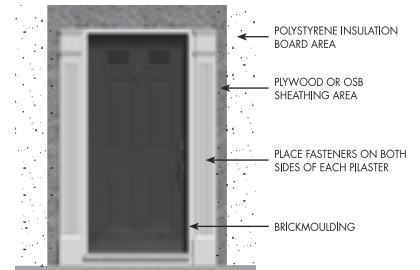
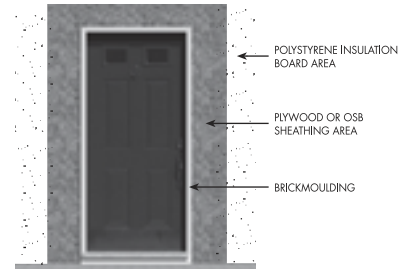

USING CORROSION-RESISTANT FASTENERS AND PL PREMIUM ADHESIVE

Always use corrosion-resistant mechanical fasteners (nails or screws) and PL Premium Adhesive when installing Fypon products. This combination provides a secure, long lasting bond. Countersink all fasteners about 1/8 inch and fill with exterior grade white spackle. If desired, sand any minor imperfections and topcoat with a quality exterior latex or oil base paint. Fypon exterior millwork installations should be finished using a quality, exterior grade silicone caulk to prevent water infiltration behind siding, windows and doors. Some exterior millwork installations, in particular new construction (before siding is applied) may require a J-channel and/or flashing to prevent water infiltration. Installers must determine which installation technique is best for the specific situation.

IMPORTANT:

Please read these installation guidelines thoroughly before beginning installation. Please note that these guidelines are provided only to assist with the installation of Fypon mouldings and millwork products. Modified procedures may be required in order to meet specific situations, unique applications and local building codes. The manufacturer does not under any circumstances warrant the installation of its products. Be sure to wear appropriate protective clothing, gloves and safety glasses when working with any tools. Installer should check for and relocate all electrical wiring within the proposed installation area, as needed (be sure to disconnect all electric power before working with any electrical wiring and follow all applicable local electrical codes and safety procedures).

New Construction - General Instructions

TECHNIQUES FOR HARDBOARD AND WOOD SIDINGS

For a new construction exterior, always prepare the area so the Fypon products can be fastened securely to the sidewall surface. Apply plywood or oriented strand board (OSB) sheathing where the millwork will be installed.

Apply a moisture-resistant house wrap material to the sheathing material as per the manufacturers recommendations before installing millwork.

PILASTERS

On the back of both Pilasters, apply a 1/4" bead of PL Premium Adhesive around the outside perimeter. Place Pilasters in position (right Pilaster on right side, etc.), aligning the edges of the Pilasters flush with the top and sides of the brickmoulding. Fasten millwork using PL Premium Adhesive and noncorrosive fasteners.

NOTE: If Pilasters need trimming, cut from the base only. Never cut the top of a Pilaster.

IMPORTANT: If a storm door is being installed — keep the brickmould in place and mount the storm door securely to the wooden brickmoulding. However, if desired and a storm door is not to be installed, the wooden brickmould material may be removed.

CROSSHEADS

To prevent water entry behind the millwork, all window or door Crossheads must be flashed, preferably with metal flashing. This is standard building construction. Do not caulk behind the Crosshead in lieu of flashing.

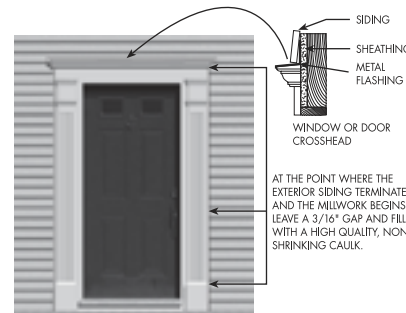
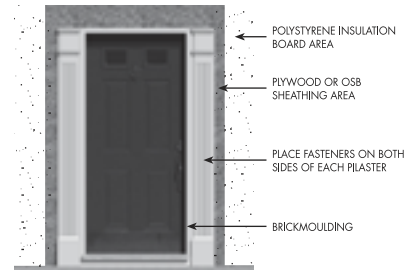
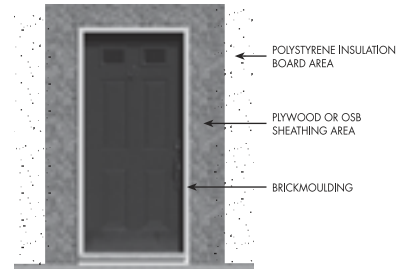

USING CORROSION-RESISTANT FASTENERS AND PL PREMIUM ADHESIVE
 Always use corrosion-resistant mechanical fasteners (nails or screws) and PL Premium Adhesive when installing Fypon products. This combination provides a secure, long lasting bond. Countersink all fasteners about 1/8 inch and fill with exterior grade white spackle. If desired, sand any minor imperfections and topcoat with a quality exterior latex or oil base paint. Fypon exterior millwork installations should be finished using a quality, exterior grade silicone caulk to prevent water infiltration behind siding, windows and doors. Some exterior millwork installations, in particular new construction (before siding is applied) may require a J-channel and/or flashing to prevent water infiltration. Installers must determine which installation technique is best for the specific situation.

IMPORTANT: Please read these installation guidelines thoroughly before beginning installation. Please note that these guidelines are provided only to assist with the installation of Fypon mouldings and millwork products. Modified procedures may be required in order to meet specific situations, unique applications and local building codes. The manufacturer does not under any circumstances warrant the installation of its products. Be sure to wear appropriate protective clothing, gloves and safety glasses when working with any tools. Installer should check for and relocate all electrical wiring within the proposed installation area, as needed (be sure to disconnect all electric power before working with any electrical wiring and follow all applicable local electrical codes and safety procedures).

Installing Siding Around Irregular Shaped Trim

FOR BOTH NEW CONSTRUCTION AND REMODELING APPLICATIONS

TECHNIQUES FOR HARDBOARD AND WOOD SIDINGS

NOTE: To prevent moisture infiltration, use house wrap as per the manufacturer's recommendations.

PILASTERS

Fasten the millwork directly to the house-wrapped sheathing using PL Premium Adhesive and noncorrosive fasteners. To prevent water entry behind the top of the brickmoulding, flash the top of the brickmoulding and pilasters.

Next, install exterior siding. At the point where the exterior siding terminates and the pilasters begin, leave a 3/16" gap and fill with a high quality, non-shrinking caulk.

IRREGULAR SHAPED CROSSHEADS

When installing irregular shaped Crossheads, it is important to apply vertical strips of vinyl undersill finish trim to prevent moisture from collecting behind the millwork. Trapped water will deteriorate the surface of the wood or hardboard siding. Use PL Premium Adhesive and galvanized roofing nails to secure the undersill strips vertically every 16"- 24" to the back of the Crosshead.

Position the Crosshead 3/16" above the top of the brick-moulding to allow any moisture that might collect to escape. Next, securely fasten the Crosshead in place using PL Premium Adhesive and non-corrosive fasteners.

Finally, countersink fasteners and fill with plastic wood filler. Sand flush and touch up with paint.

TIP: We recommend using screws when securing the Crosshead over the siding material. The extra holding strength of the screws along with the adhesive will securely hold the Crosshead in place.

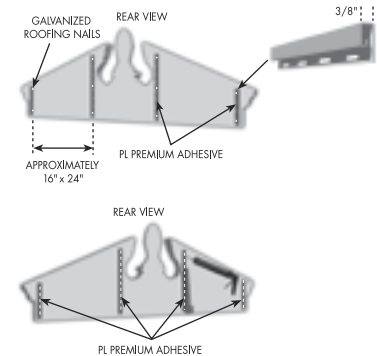
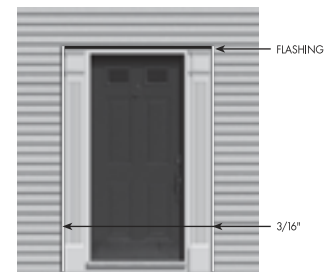
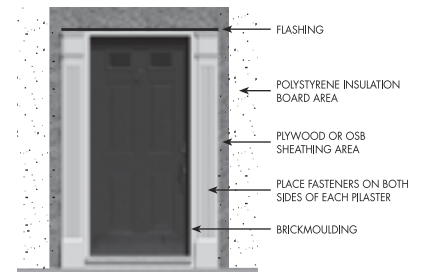

USING CORROSION-RESISTANT FASTENERS AND PL PREMIUM ADHESIVE

Always use corrosion-resistant mechanical fasteners (nails or screws) and PL Premium Adhesive when installing Fypon products. This combination provides a secure, long lasting bond. Countersink all fasteners about 1/8 inch and fill with exterior grade white spackle. If desired, sand any minor imperfections and topcoat with a quality exterior latex or oil base paint. Fypon exterior millwork installations should be finished using a quality, exterior grade silicone caulk to prevent water infiltration behind siding, windows and doors. Some exterior millwork installations, in particular new construction (before siding is applied) may require a J-channel and/or flashing to prevent water infiltration. Installers must determine which installation technique is best for the specific situation.

IMPORTANT:

Please read these installation guidelines thoroughly before beginning installation. Please note that these guidelines are provided only to assist with the installation of Fypon mouldings and millwork products. Modified procedures may be required in order to meet specific situations, unique applications and local building codes. The manufacturer does not under any circumstances warrant the installation of its products. Be sure to wear appropriate protective clothing, gloves and safety glasses when working with any tools. Installer should check for and relocate all electrical wiring within the proposed installation area, as needed (be sure to disconnect all electric power before working with any electrical wiring and follow all applicable local electrical codes and safety procedures).

Synthetic Stucco Applications

EIFS – EXTERIOR INSULATION AND FINISH SYSTEM

When installing Fypon products over an existing synthetic stucco (EIFS) surface, it is important to seal out any moisture that could collect and pool between the millwork and the synthetic stucco surface. Moisture will not harm the Fypon product; however, the surface of the synthetic stucco is susceptible to prolonged moisture pooling.

To prevent moisture problems, a high quality adhesive/sealant must be used. This type of adhesive/sealant not only bonds the millwork securely to the EIFS wall surface, but also creates a seal/gasket to prevent moisture entry behind the millwork.

1. Apply a solid bead of adhesive/sealant near the outside edge of the top and sides of the millwork. The bottom edge of the millwork should remain free of adhesive/sealant to allow moisture to escape.
2. Assess the area where the millwork will be positioned. If there is solid sheathing or framing behind the EIFS surface, millwork should be secured directly to it. However, if solid material cannot be located, the use of hollow wall fasteners will be needed. Fasteners should be kept inside the bead of adhesive/sealant.
3. When the millwork is placed snug against the wall surface, the bead of adhesive/sealant might ooze out the edges. Smooth out the bead and add additional adhesive/sealant to create a good weather proof seal that will repel water.

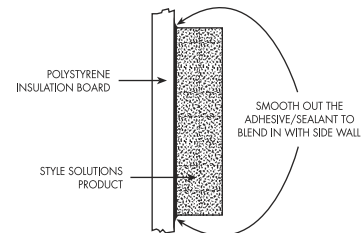
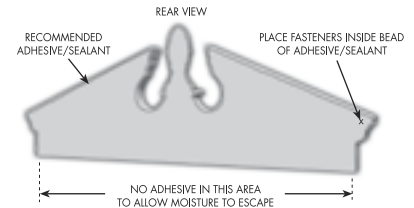
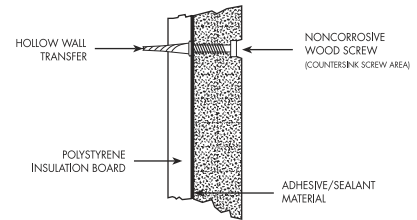
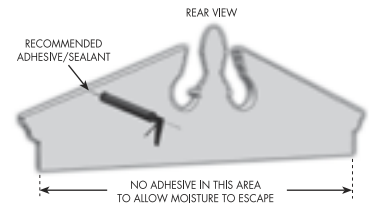

USING CORROSION-RESISTANT FASTENERS AND PL PREMIUM ADHESIVE
 Always use corrosion-resistant mechanical fasteners (nails or screws) and PL Premium Adhesive when installing Fypon products. This combination provides a secure, long lasting bond. Countersink all fasteners about 1/8 inch and fill with exterior grade white spackle. If desired, sand any minor imperfections and topcoat with a quality exterior latex or oil base paint. Fypon exterior millwork installations should be finished using a quality, exterior grade silicone caulk to prevent water infiltration behind siding, windows and doors. Some exterior millwork installations, in particular new construction (before siding is applied) may require a J-channel and/or flashing to prevent water infiltration. Installers must determine which installation technique is best for the specific situation.

IMPORTANT:
 Please read these installation guidelines thoroughly before beginning installation. Please note that these guidelines are provided only to assist with the installation of Fypon mouldings and millwork products. Modified procedures may be required in order to meet specific situations, unique applications and local building codes. The manufacturer does not under any circumstances warrant the installation of its products. Be sure to wear appropriate protective clothing, gloves and safety glasses when working with any tools. Installer should check for and relocate all electrical wiring within the proposed installation area, as needed (be sure to disconnect all electric power before working with any electrical wiring and follow all applicable local electrical codes and safety procedures).

Brick and Masonry Applications

Use a combination of masonry fasteners and PL Premium Adhesive to fasten Fypon products to brick or masonry structures. Countersink the fasteners and apply a non-shrinking filler in the indentations. Allow the wood filler to cure, then sand filled area flush. Touch up with paint.

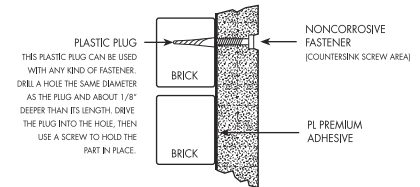

Finishing Options

Moulded of high-density urethane foam, Fypon moulded millwork products have an in-mold barrier coat, which becomes an integral part of the urethane foam as it cures.

After each piece is moulded and trimmed, we apply an exterior grade white primer paint with a built-in ultraviolet stabilizer.

Our products are impervious to moisture, so painted surfaces are not subject to the degree of chipping and peeling common with painted wood. Also, they are not subject to decay or insect damage.

PAINTING

Fypon products may be painted with any good quality latex or oil base paint. Usually one coat is all that is needed.

FAUX FINISHES

Our products are also suitable for many faux finishing techniques, including sponging, feathering, and antiquing using either oil base or latex paints.

WHITE COLOR MATCH – AVAILABLE AT SHERWIN-WILLIAMS®

To better service our customers nationwide, we have worked with Sherwin-Williams® to formulate a color and sheen match for our white paint that is applied at the factory. You can take this formulation to your local Sherwin-Williams dealer.

Formulation: Superior Exterior, Satin Latex

Paint Gallon Base: A89W51
 LI - 1/64
 WI - 6 oz.
 NI - 1/128
 Y3 - 1/128
 R1 or R4 - 1/64

STAINING

Fypon products that are noted as Woodgrain/Stainable may be stained. Apply a good quality, nonpenetrating stain (ZAR™ Olympic Overcoat™, etc.) with a 2" natural bristle brush. Begin applying stain in a circular motion, then feather the stain in the direction of the grain. For a darker finish, apply a heavy coat of stain with light pressure. For a lighter finish, apply a thin coat of stain with more pressure.

USING CORROSION-RESISTANT FASTENERS AND PL PREMIUM ADHESIVE

Always use corrosion-resistant mechanical fasteners (nails or screws) and PL Premium Adhesive when installing Fypon products. This combination provides a secure, long lasting bond. Countersink all fasteners about 1/8 inch and fill with exterior grade white spackle. If desired, sand any minor imperfections and topcoat with a quality exterior latex or oil base paint. Fypon exterior millwork installations should be finished using a quality, exterior grade silicone caulk to prevent water infiltration behind siding, windows and doors. Some exterior millwork installations, in particular new construction (before siding is applied) may require a J-channel and/or flashing to prevent water infiltration. Installers must determine which installation technique is best for the specific situation.

IMPORTANT:

Please read these installation guidelines thoroughly before beginning installation. Please note that these guidelines are provided only to assist with the installation of mouldings and millwork products. Modified procedures may be required in order to meet specific situations, unique applications and local building codes. The manufacturer does not under any circumstances warrant the installation of its products. Be sure to wear appropriate protective clothing, gloves and safety glasses when working with any tools. Installer should check for and relocate all electrical wiring within the proposed installation area, as needed (be sure to disconnect all electric power before working with any electrical wiring and follow all applicable local electrical codes and safety procedures).

Louvers

TIP: You may wish to paint, stain or faux finish your decorative millwork piece prior to installation. This can speed up installation and reduce errors.

INSTALLATION INSTRUCTIONS

MATERIALS NEEDED

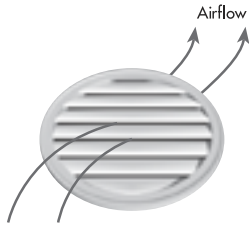

Functional Louver



Decorative Louver

Fypon manufactures two types of Louvers - decorative and functional.

Decorative Louvers have closed non-ventilating slats that do not allow air to pass through. They are used for decorative purposes only to accent exterior sidewall applications.

Functional Louvers accent exterior sidewall applications, but also have open slats that allow for air ventilation.

TO INSTALL A FUNCTIONAL LOUVER:

1. Hold the Louver against the siding.
2. Using the Louver as a template, trace the outline of the perimeter of the Louver as it rests against the siding. Check to make sure your cut will not pass through studs and electrical lines.
3. Cut a **2" undersized hole** inside the outline of the Louver.
4. Attach the Louver with corrosion-resistant fasteners and PL Premium adhesive.

TO INSTALL A DECORATIVE LOUVER:

1. Apply PL Premium Adhesive to the perimeter edge of the backside of the Louver.
2. Place the Louver in position against the exterior sidewall of the home, making sure it is level.
3. Secure Louver with non-corrosive fasteners.
4. Wipe off excess adhesive.

- Safety Glasses
- Tape Measure
- Hammer or Pneumatic Nailer
- Nail Countersink
- Corrosion-resistant Finishing Nails or Screws
- Caulk Gun
- PL Premium Adhesive
- Caulk or Wood Filler
- Sandpaper
- Pencil
- Latex or Oil Base Paint
- Ladder
- Jig Saw
(for functional Louver installation)

USING CORROSION-RESISTANT FASTENERS AND PL PREMIUM ADHESIVE

Always use corrosion-resistant mechanical fasteners (nails or screws) and PL Premium Adhesive when installing Fypon products. This combination provides a secure, long lasting bond. Countersink all fasteners about 1/8 inch and fill with exterior grade white spackle. If desired, sand any minor imperfections and topcoat with a quality exterior latex or oil base paint. Fypon exterior millwork installations should be finished using a quality, exterior grade silicone caulk to prevent water infiltration behind siding, windows and doors. Some exterior millwork installations, in particular new construction (before siding is applied) may require a J-channel and/or flashing to prevent water infiltration. Installers must determine which installation technique is best for the specific situation.

IMPORTANT:

Please read these installation guidelines thoroughly before beginning installation. Please note that these guidelines are provided only to assist with the installation of Fypon mouldings and millwork products. Modified procedures may be required in order to meet specific situations, unique applications and local building codes. The manufacturer does not under any circumstances warrant the installation of its products. Be sure to wear appropriate protective clothing, gloves and safety glasses when working with any tools. Installer should check for and relocate all electrical wiring within the proposed installation area, as needed (be sure to disconnect all electric power before working with any electrical wiring and follow all applicable local electrical codes and safety procedures).

E-Vent™ System

TIP: You may wish to paint your E-Vent™ system prior to installation. This can speed up installation and reduce errors.

INSTALLATION INSTRUCTIONS

MATERIALS NEEDED



1. DRAW A LAYOUT OF THE ROOFLINE

Begin by drawing a simple layout of the roofline. Determine the location and quantities of the parts you need.

2. APPLY ADHESIVE AND SET CORNER INTO PLACE

Starting with one of the corners,* apply a bead of quality urethane base construction adhesive (we recommend PL Premium brand adhesive) to the backside and mitered joint of the corner and set it into place. Snug it into place.

**Corner is shipped in two pieces and requires assembly before installation.*

3. FASTEN CORNER PIECES

Fasten the corner piece with nails or screws. Continue with all other inside and outside corners of the roof.

4. DETERMINE MOULDING LENGTHS

Using your roofline layout drawing as a guide, measure the length of the first trim piece you need. To ensure a snug fit on longer lengths, add 1/8" to every five feet (1/4" every ten feet). Transfer your measurement (don't forget to add 1/8" for every five feet) and cut the first piece to length. Check the fit by laying the piece in place.

5. SET MOULDING INTO PLACE

Apply a bead of adhesive to the surfaces that the E-Vent will touch. Lay the first piece into place. Note: Because you cut them slightly long, some pieces will spring into place, and will be slightly bowed. This is normal. The piece will flatten as it is screwed into the wall.

6. FASTEN THE MOULDING

Starting with the ends first, fasten the E-Vent with nails or screws. Work toward the middle, driving nails or screws every 16". Again, the extra 1/8" per every five feet will flatten as you move toward the center.

7. FILL HOLES AND FINISH AS DESIRED

Continue to install the E-Vent system, until the entire system is done. If desired, fill nail or screw holes with caulk or filler, as well as any gaps along the wall and ceiling surfaces. Once caulk is dry, you can paint as desired.

Safety Glasses
Tape Measure
Hammer or Pneumatic Nailer
Nail Countersink
Corrosion-resistant Finishing Nails or Screws
Caulk Gun
PL Premium Adhesive
Caulk or Wood Filler
Sandpaper
Pencil
Latex or Oil Base Paint
Miter Saw
Ladder and/or Scaffolding

USING CORROSION-RESISTANT FASTENERS AND PL PREMIUM ADHESIVE

Always use corrosion-resistant mechanical fasteners (nails or screws) and PL Premium Adhesive when installing Fypon products. This combination provides a secure, long lasting bond. Countersink all fasteners about 1/8 inch and fill with exterior grade white spackle. If desired, sand any minor imperfections and topcoat with a quality exterior latex or oil base paint. Fypon exterior millwork installations should be finished using a quality, exterior grade silicone caulk to prevent water infiltration behind siding, windows and doors. Some exterior millwork installations, in particular new construction (before siding is applied) may require a J-channel and/or flashing to prevent water infiltration. Installers must determine which installation technique is best for the specific situation.

IMPORTANT:

Please read these installation guidelines thoroughly before beginning installation. Please note that these guidelines are provided only to assist with the installation of Fypon mouldings and millwork products. Modified procedures may be required in order to meet specific situations, unique applications and local building codes. The manufacturer does not under any circumstances warrant the installation of its products. Be sure to wear appropriate protective clothing, gloves and safety glasses when working with any tools. Installer should check for and relocate all electrical wiring within the proposed installation area, as needed (be sure to disconnect all electric power before working with any electrical wiring and follow all applicable local electrical codes and safety procedures).

Pilasters

INSTALLATION INSTRUCTIONS

MATERIALS NEEDED

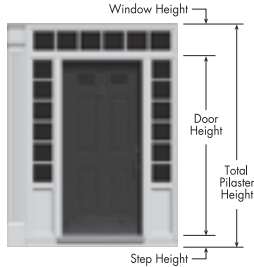

MEASURING PILASTERS

MEASURING PILASTERS

To determine the required height of the Pilaster, measure the distance from the landing or porch floor to the top of the door, including brickmoulding if applicable. Be sure to include the height of any transom or over-the-door window.

CUTTING PILASTERS TO CORRECT DIMENSION:

To handle the variety of different heights of pilasters needed for numerous applications, Fypon, Ltd. manufactures two different types of Pilasters that can be adjusted for height.

1. ONE-PIECE PILASTER MOULDED WITH PLINTH BLOCK

The Plinth Block (base) is moulded to the Pilaster as a one-piece unit. Any trimming for height needs to be done at the base, or Plinth Block area of the Pilaster.

2. PILASTER WITH ADJUSTABLE PLINTH BLOCK

The Pilaster and the Plinth Block (base) are two separate pieces. The Pilaster can be adjusted for height by trimming at the base, along the fluted area of the Pilaster. The Plinth Block may also be trimmed. Then the Plinth Block is simply installed over the fluted section.



STEP 1

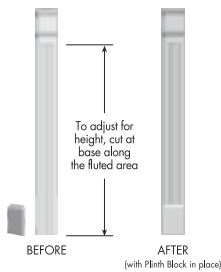

STEP 2

- Safety Glasses
- Tape Measure
- Hammer or Pneumatic Nailer
- Nail Countersink
- Corrosion-resistant Finishing Nails
- Caulk Gun
- PL Premium Adhesive
- Caulk or Wood Filler
- Sandpaper
- Pencil
- Latex or Oil Base Paint
- Miter Saw

USING CORROSION-RESISTANT FASTENERS AND PL PREMIUM ADHESIVE

Always use corrosion-resistant mechanical fasteners (nails or screws) and PL Premium Adhesive when installing Fypon products. This combination provides a secure, long lasting bond. Countersink all fasteners about 1/8 inch and fill with exterior grade white spackle. If desired, sand any minor imperfections and topcoat with a quality exterior latex or oil base paint. Fypon exterior millwork installations should be finished using a quality, exterior grade silicone caulk to prevent water infiltration behind siding, windows and doors. Some exterior millwork installations, in particular new construction (before siding is applied) may require a J-channel and/or flashing to prevent water infiltration. Installers must determine which installation technique is best for the specific situation.

IMPORTANT:

Please read these installation guidelines thoroughly before beginning installation. Please note that these guidelines are provided only to assist with the installation of Fypon mouldings and millwork products. Modified procedures may be required in order to meet specific situations, unique applications and local building codes. The manufacturer does not under any circumstances warrant the installation of its products. Be sure to wear appropriate protective clothing, gloves and safety glasses when working with any tools. Installer should check for and relocate all electrical wiring within the proposed installation area, as needed (be sure to disconnect all electric power before working with any electrical wiring and follow all applicable local electrical codes and safety procedures).

Crossheads for Doors and Windows

INSTALLATION INSTRUCTIONS

MATERIALS NEEDED

- Safety Glasses
- Tape Measure
- Hammer or Pneumatic Nailer
- Handsaw
- Nail Countersink
- Corrosion-resistant Finishing Nails or Screws
- Caulk Gun
- PL Premium Adhesive
- Caulk or Wood Filler
- Sandpaper
- Pencil
- Latex or Oil Base Paint

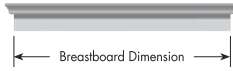

All Fypon door and window Crossheads are measured from and ordered in relationship to the Breastboard dimension.

Crosshead widths are available in the following options:

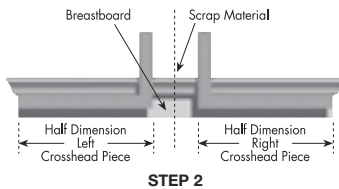

SPECIAL MADE FABRICATION

Fypon can provide custom Crossheads in one piece when the requested size is smaller than the largest standard size. Widths larger than the largest standard size will ship in two or more pieces. **See price book for information on ordering special crossheads.**

CUSTOM WIDTHS CREATED ON THE JOB

1. To customize widths on the job, order your Crosshead in a stock oversized width.
2. Take the desired width of the Crosshead, divide the dimension in half. This measurement represents the width of each side of the Crosshead. Next, measure from the right of the Crosshead breastboard the "half" dimension. Mark the measurement using a pencil and framing square. Do the same from the left side of the Crosshead breastboard. Cut the Crosshead at the pencil marks. The center portion of the Crosshead will be scrap material.
3. Place the right and left Crosshead pieces on top of the entrance opening, aligning the outer edge of the Crosshead breastboard with the outer edge of the entrance opening or Pilasters. Securely fasten each Crosshead through the breastboard using PL Premium Adhesive and the necessary fasteners.
4. To cover the seam at the center of the Crosshead, overlay the Keystone onto the Crosshead and center it over the opening. Fasten the Keystone to the Crosshead using PL Premium Adhesive and fasteners. Countersink fastener holes, and fill for a finished look.

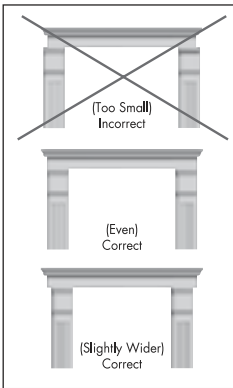
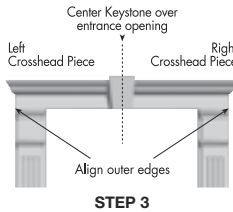

NOTE: It is architecturally acceptable to install Crossheads slightly wider than the opening as long as the overhang is even on both sides.

USING CORROSION-RESISTANT FASTENERS AND PL PREMIUM ADHESIVE

Always use corrosion-resistant mechanical fasteners (nails or screws) and PL Premium Adhesive when installing Fypon products. This combination provides a secure, long lasting bond. Countersink all fasteners about 1/8 inch and fill with exterior grade white spackle. If desired, sand any minor imperfections and topcoat with a quality exterior latex or oil base paint. Fypon exterior millwork installations should be finished using a quality, exterior grade silicone caulk to prevent water infiltration behind siding, windows and doors. Some exterior millwork installations, in particular new construction (before siding is applied) may require a J-channel and/or flashing to prevent water infiltration. Installers must determine which installation technique is best for the specific situation.

IMPORTANT:

Please read these installation guidelines thoroughly before beginning installation. Please note that these guidelines are provided only to assist with the installation of Fypon mouldings and millwork products. Modified procedures may be required in order to meet specific situations, unique applications and local building codes. The manufacturer does not under any circumstances warrant the installation of its products. Be sure to wear appropriate protective clothing, gloves and safety glasses when working with any tools. Installer should check for and relocate all electrical wiring within the proposed installation area, as needed (be sure to disconnect all electric power before working with any electrical wiring and follow all applicable local electrical codes and safety procedures).

Window Trim Kit

INSTALLATION INSTRUCTIONS

MATERIALS NEEDED

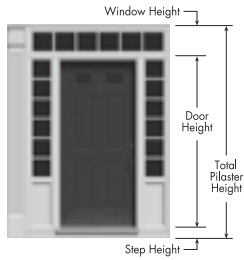

FIGURE A



FIGURE B

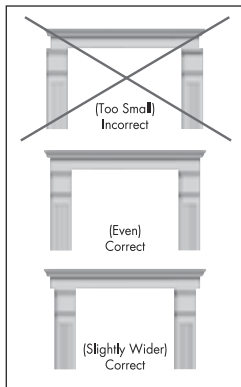

FIGURE C

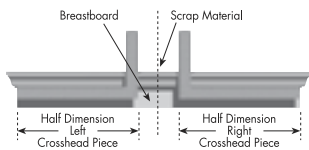

FIGURE D

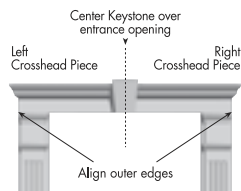

FIGURE E

INSTALLING WINDOW TRIM

Install window trim moulding using corrosion-resistant fasteners and PL Premium Adhesive. Carefully measure the side height (vertical) and bottom width (horizontal) of the window. Cut the moulding to the sizes measured. Use square Plinth Blocks, or "PB's" (also commonly called rosettes) at all corners, for a finished appearance (SEE FIGURE A).

INSTALLING CROSSHEADS ABOVE WINDOWS, DOORS AND GARAGE DOORS

Crossheads look best when their breastboard is the same width as the window or door, plus any trim (SEE FIGURE B). It is acceptable to install Crossheads with breastboards that are slightly wider than the opening and trim, as long as the overhang is even on both sides (SEE FIGURE C).

1. Measure the distance from one outside edge of the window or door, plus any trim, to the other outside edge (horizontal measurement).

2. If your Crosshead is equal to or slightly wider than this measurement, install it centered above the window or door using corrosion-resistant fasteners and PL Premium polyurethane construction adhesive (see "Using Fasteners and PL Premium Adhesive," below). Add a Keystone, centered on the Crosshead, for a classic appearance. Fasten the Keystone to the Crosshead using PL Premium Adhesive and fasteners.

If your Crosshead is more than 2 inches wider than the measurement you made in step one, you should cut the Crosshead in the center and remove an equal amount from both sides (SEE FIGURE D).

The two remaining pieces, when combined, will fit above your opening. Install them using corrosion-resistant nails or screws and PL Premium polyurethane construction adhesive.

If your Crosshead is narrower than the measurement you made in step one, you will need to either use a larger Crosshead or combine two Crossheads to create one larger Crosshead. To combine two Crossheads, use one to create a left Crosshead piece, and use the other to create a right Crosshead piece. Each piece should be 1/2 of the original measurement you made. BE SURE TO MEASURE FROM THE LEFT SIDE OF ONE CROSSHEAD, AND FROM THE RIGHT SIDE OF THE OTHER, SO THAT THEY JOIN IN THE MIDDLE TO FORM A SINGLE, LARGER CROSSHEAD.

Cover the seam at the center of a combined Crosshead using a Keystone. Fasten the Keystone to the Crosshead using PL Premium Adhesive and fasteners (SEE FIGURE E).

- Tape Measure
- Framing Square
- Hammer
- Screwdriver
- Miter Saw
- Nail Countersink
- Caulk Gun
- Pencil
- Safety Glasses
- PL Premium Construction Adhesive
- Wood Filler
- Sandpaper (very fine)
- Exterior Grade Caulk
- Galvanized Nails, Corrosion-resistant Screws or Threaded Concrete Fasteners (brick application)

USING CORROSION-RESISTANT FASTENERS AND PL PREMIUM ADHESIVE

Always use corrosion-resistant mechanical fasteners (nails or screws) and PL Premium Adhesive when installing Fypon products. This combination provides a secure, long lasting bond. Countersink all fasteners about 1/8 inch and fill with exterior grade white spackle. If desired, sand any minor imperfections and topcoat with a quality exterior latex or oil base paint. Fypon exterior millwork installations should be finished using a quality, exterior grade silicone caulk to prevent water infiltration behind siding, windows and doors. Some exterior millwork installations, in particular new construction (before siding is applied) may require a J-channel and/or flashing to prevent water infiltration. Installers must determine which installation technique is best for the specific situation.

IMPORTANT:

Please read these installation guidelines thoroughly before beginning installation. Please note that these guidelines are provided only to assist with the installation of Fypon mouldings and millwork products. Modified procedures may be required in order to meet specific situations, unique applications and local building codes. The manufacturer does not under any circumstances warrant the installation of its products. Be sure to wear appropriate protective clothing, gloves and safety glasses when working with any tools. Installer should check for and relocate all electrical wiring within the proposed installation area, as needed (be sure to disconnect all electric power before working with any electrical wiring and follow all applicable local electrical codes and safety procedures).

Door Trim Kit

INSTALLATION INSTRUCTIONS

MATERIALS NEEDED

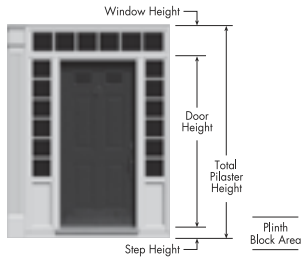

FIGURE A



FIGURE B

INSTALLING PILASTERS AS SIDE TRIM FOR DOORS AND GARAGE DOORS

1. Determine the required height of the Pilaster by measuring the distance from the landing or porch floor to the top of the door, including any existing trim or brickmould. Be sure to include the height of any transom or over-the-door window (SEE FIGURE A).
2. To make installation easier, Fypon Pilasters include a Plinth Block (base) that is moulded to the Pilaster as one unit. Any trimming for height is done at the bottom (Plinth Block or base) end of the Pilaster (SEE FIGURE B).
3. After trimming Pilasters to the correct height, install them using non-corrosive fasteners and PL Premium adhesive.



FIGURE C

INSTALLING CROSSHEADS ABOVE WINDOWS, DOORS AND GARAGE DOORS

Crossheads look best when their breasboard is the same width as the window or door, plus any trim (SEE FIGURE C). It is acceptable to install Crossheads with breasboards that are slightly wider than the opening and trim, as long as the overhang is even on both sides (SEE FIGURE D).

1. Measure the distance from one outside edge of the window or door, plus any trim, to the other outside edge (horizontal measurement).
2. If your Crosshead is equal to or slightly wider than this measurement, install it centered above the window or door using corrosion-resistant fasteners and PL Premium polyurethane construction adhesive (see "Using Fasteners and PL Premium Adhesive," below). Add a Keystone, centered on the Crosshead, for a classic appearance. Fasten the Keystone to the Crosshead using PL Premium Adhesive and fasteners.

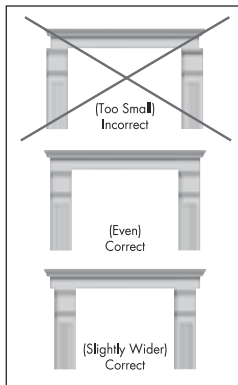

FIGURE D

If your Crosshead is more than 2 inches wider than the measurement you made in step one, you should cut the Crosshead in the center and remove an equal amount from both sides (SEE FIGURE E).

The two remaining pieces, when combined, will fit above your opening. Install them using corrosion-resistant nails or screws and PL Premium polyurethane construction adhesive.

If your Crosshead is narrower than the measurement you made in step one, you will need to either use a larger Crosshead or combine two Crossheads to create one larger Crosshead. To combine two Crossheads, use one to create a left Crosshead piece, and use the other to create a right Crosshead piece. Each piece should be 1/2 of the original measurement you made. BE SURE TO MEASURE FROM THE LEFT SIDE OF ONE CROSSHEAD, AND FROM THE RIGHT SIDE OF THE OTHER, SO THAT THEY JOIN IN THE MIDDLE TO FORM A SINGLE, LARGER CROSSHEAD.

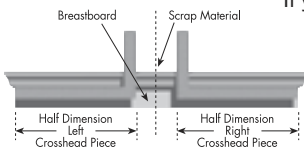

FIGURE E

Cover the seam at the center of a combined Crosshead using a Keystone. Fasten the Keystone to the Crosshead using PL Premium Adhesive and fasteners (SEE FIGURE F).

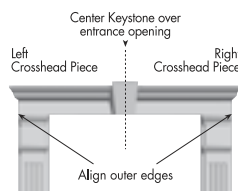

FIGURE F

USING CORROSION-RESISTANT FASTENERS AND PL PREMIUM ADHESIVE

Always use corrosion-resistant mechanical fasteners (nails or screws) and PL Premium Adhesive when installing Fypon products. This combination provides a secure, long lasting bond. Countersink all fasteners about 1/8 inch and fill with exterior grade white spackle. If desired, sand any minor imperfections and topcoat with a quality exterior latex or oil base paint. Fypon exterior millwork installations should be finished using a quality, exterior grade silicone caulk to prevent water infiltration behind siding, windows and doors. Some exterior millwork installations, in particular new construction (before siding is applied) may require a J-channel and/or flashing to prevent water infiltration. Installers must determine which installation technique is best for the specific situation.

IMPORTANT:

Please read these installation guidelines thoroughly before beginning installation. Please note that these guidelines are provided only to assist with the installation of Fypon mouldings and millwork products. Modified procedures may be required in order to meet specific situations, unique applications and local building codes. The manufacturer does not under any circumstances warrant the installation of its products. Be sure to wear appropriate protective clothing, gloves and safety glasses when working with any tools. Installer should check for and relocate all electrical wiring within the proposed installation area, as needed (be sure to disconnect all electric power before working with any electrical wiring and follow all applicable local electrical codes and safety procedures).

Detailed Mouldings

INSTALLATION INSTRUCTIONS

MATERIALS NEEDED

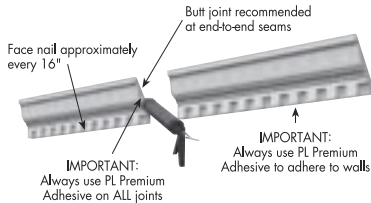

Fypon products can be cut and trimmed with typical woodworking tools. They are installed similar to any premium wood trim with a couple of important rules to keep in mind.

- The urethane foam used in Fypon products will expand during hot temperatures and contract during cold temperatures. **To minimize the effects of expansion and contraction it is very important to install moulding as tightly as possible.** We recommend cutting moulding 1/4" longer for each 10' of length to insure a snug fit. Also, use butt joints on all seams, and mitered joints at the corners to insure a tight fit.

- It is very important to use a top quality, urethane construction adhesive such as PL Premium Adhesive for installations.** Using this adhesive on all joints (covering the joint completely) and along the back of the moulding will ensure the highest quality installation.
- Mouldings should be installed on solid backing material. Fasten mouldings in place every 16" or less.

REPAIR TIP

- To repair a butt joint that has separated due to insufficient or NO adhesive applied, drive wood shims into the joint and below the surface of the millwork. This will open up the separation and stabilize it. Leaving shims in place, fill the gap with PL Premium Adhesive as a filler. Then sand the joint and touch up with paint.

NOTE: The best time of year to repair separated joints is during cold temperatures when moulding is fully contracted.

- Safety Glasses
- Tape Measure
- Hammer or Pneumatic Nailer
- Nail Countersink
- Corrosion-resistant Finishing Nails
- Caulk Gun
- PL Premium Adhesive
- Caulk or Wood Filler
- Sandpaper
- Pencil
- Latex or Oil Base Paint

USING CORROSION-RESISTANT FASTENERS AND PL PREMIUM ADHESIVE

Always use corrosion-resistant mechanical fasteners (nails or screws) and PL Premium Adhesive when installing Fypon products. This combination provides a secure, long lasting bond. Countersink all fasteners about 1/8 inch and fill with exterior grade white spackle. If desired, sand any minor imperfections and topcoat with a quality exterior latex or oil base paint. Fypon exterior millwork installations should be finished using a quality, exterior grade silicone caulk to prevent water infiltration behind siding, windows and doors. Some exterior millwork installations, in particular new construction (before siding is applied) may require a J-channel and/or flashing to prevent water infiltration. Installers must determine which installation technique is best for the specific situation.

IMPORTANT:

Please read these installation guidelines thoroughly before beginning installation. Please note that these guidelines are provided only to assist with the installation of Fypon mouldings and millwork products. Modified procedures may be required in order to meet specific situations, unique applications and local building codes. The manufacturer does not under any circumstances warrant the installation of its products. Be sure to wear appropriate protective clothing, gloves and safety glasses when working with any tools. Installer should check for and relocate all electrical wiring within the proposed installation area, as needed (be sure to disconnect all electric power before working with any electrical wiring and follow all applicable local electrical codes and safety procedures).

Miterless Crown Moulding System

TIP: You may wish to paint, stain or faux finish your decorative millwork piece prior to installation. This can speed up installation and reduce errors.

INSTALLATION INSTRUCTIONS

MATERIALS NEEDED



STEP 2

1. DRAW A LAYOUT OF THE ROOM

Begin by drawing a simple layout of the room. Determine the location and quantities of the parts you need. Hint: Use divider blocks to create your own special design. They hide the seams, adding beauty and making the Miterless Crown Moulding System easy to install.



STEP 3

2. APPLY ADHESIVE AND SET CORNER INTO PLACE

Starting with one of the corners, apply a bead of quality urethane base construction adhesive (we recommend PL Premium brand adhesive) to the backside and all contact points of the miterless corner and set it into place. Snug the wall and the ceiling.



STEP 4

3. FASTEN CORNER PIECES

Fasten the corner piece with nails or screws, hiding nails or screws by driving them into decorative or recessed areas of the corner piece. Continue with all other inside and outside corners in the room.



STEP 5

4. INSTALL DIVIDER BLOCKS

Apply adhesive to the back and side of the first moulding divider block. Set it into place tight against the miterless corner and fasten with nails or screws. Install a divider block on both sides of all corners in the room. Using your layout as a guide, fasten all additional divider blocks in place.



STEP 6

5. DETERMINE MOULDING LENGTHS

Using your room layout drawing as a guide, measure the length of the first moulding piece you need. To ensure a snug fit on longer lengths, add 1/8" to every five feet (1/4" every ten feet). Transfer your measurement (don't forget to add 1/8" for every five feet) and cut the first piece to length. Check the fit by laying the piece in place.



STEP 7

6. SET MOULDING INTO PLACE

Apply a bead of adhesive to the surfaces that will touch the wall, ceiling and edge of the divider blocks. Lay the first piece into place. Note: Because you cut them slightly long, some pieces will spring into place, and will be slightly bowed. This is normal. The piece will flatten as it is screwed into the wall.



STEP 8

7. FASTEN THE MOULDING

Starting with the ends first, fasten the moulding with nails or screws. Work toward the middle, driving nails or screws every 16". Again, the extra 1/8" per every five feet will flatten as you move toward the center.



STEP 8

8. FILL HOLES AND FINISH AS DESIRED

Continue to install the moulding, until the entire crown is done. If desired, fill nail or screw holes with caulk or filler, as well as any gaps along the wall and ceiling surfaces. Once caulk is dry, you can paint, stain or faux finish as desired.

USING CORROSION-RESISTANT FASTENERS AND PL PREMIUM ADHESIVE

Always use corrosion-resistant mechanical fasteners (nails or screws) and PL Premium Adhesive when installing Fypon products. This combination provides a secure, long lasting bond. Countersink all fasteners about 1/8 inch and fill with exterior grade white spackle. If desired, sand any minor imperfections and topcoat with a quality exterior latex or oil base paint. Fypon exterior millwork installations should be finished using a quality, exterior grade silicone caulk to prevent water infiltration behind siding, windows and doors. Some exterior millwork installations, in particular new construction (before siding is applied) may require a J-channel and/or flashing to prevent water infiltration. Installers must determine which installation technique is best for the specific situation.

IMPORTANT:

Please read these installation guidelines thoroughly before beginning installation. Please note that these guidelines are provided only to assist with the installation of Fypon mouldings and millwork products. Modified procedures may be required in order to meet specific situations, unique applications and local building codes. The manufacturer does not under any circumstances warrant the installation of its products. Be sure to wear appropriate protective clothing, gloves and safety glasses when working with any tools. Installer should check for and relocate all electrical wiring within the proposed installation area, as needed (be sure to disconnect all electric power before working with any electrical wiring and follow all applicable local electrical codes and safety procedures).

Decorative Millwork

TIP: You may wish to paint, stain or faux finish your decorative millwork piece prior to installation. This can speed up installation and reduce errors.

INSTALLATION INSTRUCTIONS

MATERIALS NEEDED



1. MARK INSTALLATION AREA

Select the location for your Decorative Millwork. Hold the millwork in place and mark the location with a pencil.

2. APPLY ADHESIVE

Apply a 1/4" bead of PL Premium Adhesive to only the portion of the millwork surface that will touch the mounting surface.

3. FASTEN MILLWORK INTO PLACE

Press the millwork in place using the pencil marks as guides. Fasten securely with nails or screws. Countersink fasteners and fill holes with caulk or wood filler.

4. FILL GAPS

If desired, caulk around millwork, filling any gaps between millwork and mounting surfaces.

5. FINISH AS DESIRED

Sand or texture any filled holes and touch up with paint or other finishes, as desired.

Tape Measure

Hammer or
Pneumatic Nailer

Corrosion-resistant Nails

Nail Countersink

Caulk Gun

PL Premium Adhesive

Safety Glasses

Caulk or Wood Filler

Sandpaper

Pencil

Latex or Oil Base Paint

USING CORROSION-RESISTANT FASTENERS AND PL PREMIUM ADHESIVE

Always use corrosion-resistant mechanical fasteners (nails or screws) and PL Premium Adhesive when installing Fypon products. This combination provides a secure, long lasting bond. Countersink all fasteners about 1/8 inch and fill with exterior grade white spackle. If desired, sand any minor imperfections and topcoat with a quality exterior latex or oil base paint. Fypon exterior millwork installations should be finished using a quality, exterior grade silicone caulk to prevent water infiltration behind siding, windows and doors. Some exterior millwork installations, in particular new construction (before siding is applied) may require a J-channel and/or flashing to prevent water infiltration. Installers must determine which installation technique is best for the specific situation.

IMPORTANT:

Please read these installation guidelines thoroughly before beginning installation. Please note that these guidelines are provided only to assist with the installation of Fypon mouldings and millwork products. Modified procedures may be required in order to meet specific situations, unique applications and local building codes. The manufacturer does not under any circumstances warrant the installation of its products. Be sure to wear appropriate protective clothing, gloves and safety glasses when working with any tools. Installer should check for and relocate all electrical wiring within the proposed installation area, as needed (be sure to disconnect all electric power before working with any electrical wiring and follow all applicable local electrical codes and safety procedures).

One-piece Medallions

TIP: *Fypon Medallions come standard with a ready-to-install, double UV protective white finish. You can customize your Medallion with latex or oil-base paints, faux finishes, gold leaf, sponging, feathering or marbleizing techniques to create your own, one-of-a-kind masterpiece. If you decide to paint, stain or faux finish your Medallion, it may work best to do this before installation. This can speed up the project by preventing any spills onto the ceiling or surrounding wall.*

INSTALLATION INSTRUCTIONS

MATERIALS NEEDED



STEP 4

IMPORTANT

When installing around or near any electrical fixture, make sure the power supply is turned off at the fuse box or circuit breaker. Be sure to follow local electrical and building codes.

1. CUT THE CENTER HOLE

NOTE: *If you are installing a Medallion with a center hole pre-cut, you may proceed to step three, below. If you are installing a solid Medallion around a fixture, you need to make a center hole to match the base of the fixture. If possible, use the fixture base itself as a template. Otherwise, carefully measure the base of the fixture. Determine the size hole you will need to cut. Transfer your measurement to the Medallion, drawing a circle around the center point. Use a drill to make a starting hole. Using a hole saw, keyhole saw or jig saw, carefully cut out the opening.*



STEP 5

2. CHECK THE FIT AND TRIM ACCORDINGLY

Set your Medallion in place to check its fit. If installing around an electrical box, make sure there is enough clearance for any hardware connecting the box to your fixture. Trim to fit as needed.



STEP 6

3. INSERT SCREWS

Start trim head screws into the Medallion's front side, equally spaced around the outside of the Medallion, staying 1"-2" from the edge. No pre-drilling is necessary. Place the screws in a detailed area, if possible. This will help to hide them.



STEP 7

4. APPLY ADHESIVE

For smooth ceilings and surfaces, apply a 1/4" bead of adhesive to the back of the Medallion about 1/2" from the edge. For textured ceilings and surfaces, apply the adhesive bead about 2" from the edge.



STEP 8

5. INSTALL MEDALLION

Put your Medallion into place and drive the trim head that they countersink to a depth of 1/8."

6. REMOVE EXCESS ADHESIVE AND FILL HOLES

With a damp cloth, remove and blend any excess adhesive that squeezed out. Fill screw holes with caulk or wood filler and smooth or texture them as desired.



STEP 9

7. SAND IMPERFECTIONS AND FINISH AS DESIRED

After the Medallion has dried in place for 2 hours or more, any minor imperfections may be sanded. You can then also finish the Medallion with any quality latex or oil base paint, etc. (SEE 'TIP' ABOVE).

8. REINSTALL FIXTURE

A removed fixture should be reinstalled once any final finish has dried. Because some Medallions are thicker than others, you may need to use a longer threaded tube in order to achieve the desired result.



STEP 8

You may not need these materials, depending upon the type of Medallion you are installing and your desired result.

- Ladder
- Tape Measure
- Screwdriver
- Paintbrush
- Safety Glasses
- Painter's Caulk, Spackle or Wood Filler
- Sandpaper
- Threaded Tube (not provided)
- Trim Head Screws (not provided)
- Latex or Oil Base Paint
- PL Premium Adhesive

USING CORROSION-RESISTANT FASTENERS AND PL PREMIUM ADHESIVE

Always use corrosion-resistant mechanical fasteners (nails or screws) and PL Premium Adhesive when installing Fypon products. This combination provides a secure, long lasting bond. Countersink all fasteners about 1/8 inch and fill with exterior grade white spackle. If desired, sand any minor imperfections and topcoat with a quality exterior latex or oil base paint. Fypon exterior millwork installations should be finished using a quality, exterior grade silicone caulk to prevent water infiltration behind siding, windows and doors. Some exterior millwork installations, in particular new construction (before siding is applied) may require a J-channel and/or flashing to prevent water infiltration. Installers must determine which installation technique is best for the specific situation.

IMPORTANT:

Please read these installation guidelines thoroughly before beginning installation. Please note that these guidelines are provided only to assist with the installation of Fypon mouldings and millwork products. Modified procedures may be required in order to meet specific situations, unique applications and local building codes. The manufacturer does not under any circumstances warrant the installation of its products. Be sure to wear appropriate protective clothing, gloves and safety glasses when working with any tools. Installer should check for and relocate all electrical wiring within the proposed installation area, as needed (be sure to disconnect all electric power before working with any electrical wiring and follow all applicable local electrical codes and safety procedures).

Two-piece Medallions

INSTALLATION INSTRUCTIONS

MATERIALS NEEDED



Installing a Fypon Medallion is a fast and easy project. Medallions come with a white double UV-protective primer and may be painted with latex or oil base paint. They can also be finished using faux techniques such as gold leaf or marbleizing.

IMPORTANT:

When installing Fypon Medallions near an electrical light fixture, make sure the power supply is turned off at the fuse box or circuit breaker box.

1. Set your Medallion in place to check its fit. Make sure there is enough clearance for any hardware connecting the box to your fixture. Trim to fit as needed. Hold the two pieces in place around the light canopy, to be sure the Medallion is centered. Using a pencil, mark its position with a fine line.
2. Lay the Medallion on a flat surface and apply adhesive to the back of the Medallion. For smooth ceilings and surfaces, apply a 1/4" bead of adhesive to the back of the Medallion about 1/2" from the edge. For textured ceilings and surfaces, apply the adhesive bead about 2" from the edge.
3. Place one side of the Medallion in position, using the pencil outline drawn on the ceiling as a guide. Start trim head screws into the Medallion's front side. Equally space them around the outside of the Medallion, staying 1"-2" from the edge in a detailed area if possible. This will help to hide them. Do not tighten the screws. Repeat for the other side locking the two pieces together.
4. Once the Medallion is in place, drive the trim head screws in so that they countersink to a depth of 1/8".
5. With a damp cloth, remove and blend any excess adhesive that squeezed out. Fill screw holes with caulk or wood filler and smooth or texture them as desired. Fill any visible joint cracks with caulk and wipe clean.
6. After the adhesive has dried in place for 2 hours or more, any minor imperfections may be sanded. You can then also finish the Medallion with any quality latex or oil base paint, faux finish, etc.
7. A removed fixture should be reinstalled once any final finish has dried. Because some Medallions are thicker than others, you may need to use a longer threaded tube in order to achieve the desired result. This tube may be purchased at a local hardware store.

Ladder
Tape Measure
Screwdriver
Paintbrush
Safety Glasses
Painter's Caulk, Spackle or Wood Filler
Sandpaper
Threaded Tube (not provided)
Trim Head Screws (not provided)
Latex or Oil Base Paint
PL Premium Adhesive

USING CORROSION-RESISTANT FASTENERS AND PL PREMIUM ADHESIVE

Always use corrosion-resistant mechanical fasteners (nails or screws) and PL Premium Adhesive when installing Fypon products. This combination provides a secure, long lasting bond. Countersink all fasteners about 1/8 inch and fill with exterior grade white spackle. If desired, sand any minor imperfections and topcoat with a quality exterior latex or oil base paint. Fypon exterior millwork installations should be finished using a quality, exterior grade silicone caulk to prevent water infiltration behind siding, windows and doors. Some exterior millwork installations, in particular new construction (before siding is applied) may require a J-channel and/or flashing to prevent water infiltration. Installers must determine which installation technique is best for the specific situation.

IMPORTANT:

Please read these installation guidelines thoroughly before beginning installation. Please note that these guidelines are provided only to assist with the installation of Fypon mouldings and millwork products. Modified procedures may be required in order to meet specific situations, unique applications and local building codes. The manufacturer does not under any circumstances warrant the installation of its products. Be sure to wear appropriate protective clothing, gloves and safety glasses when working with any tools. Installer should check for and relocate all electrical wiring within the proposed installation area, as needed (be sure to disconnect all electric power before working with any electrical wiring and follow all applicable local electrical codes and safety procedures).

Domes

INSTALLATION INSTRUCTIONS

MATERIALS NEEDED



1. CREATE A ROUGH OPENING TEMPLATE

Use a large flattened section of the cardboard packaging shipped with the Dome. Lay the Dome on the packaging. Trace the outline. The Dome is manufactured with four alignment lines. Mark the locations of these four lines onto the cardboard template. Remove the Dome from the template. Next, mark inside the entire outline about 1 1/2". Then, transfer the alignment line markings to the inside line you just drew, marking in toward the center of the template. Using a utility knife or heavy duty scissors, cut along the inside line to create the rough opening template. Make sure that the alignment marks are still visible on the inside piece that you cut out.

2. MARK DOME LOCATION AND ALIGNMENT ON CEILING

Mark the desired center point location on the ceiling. Next draw a straight line out from the center point, in both directions. Note: For a circular Dome, the straight line should be parallel to one of the walls in the room. For an oval Dome, the straight line should be oriented in the direction (lengthwise) that you want for the Dome (usually this is also parallel to one wall). Using a framing square, draw another line at a 90 degree angle to the first, through the center point and the orientation line you drew, above.

3. PLACE TEMPLATE ON CEILING

Align the cardboard template on the ceiling. If installing an oval Dome, be sure to line up the template in the right direction. Screw the template into the ceiling, using drywall screws.

4. PREPARING THE ROUGH OPENING

For Frame and Wallboard Construction: Cut through the wallboard along the outside edge of the template. Remove the wallboard. **If there are no joists, electrical wiring or plumbing lines that are in the way or could interfere with installation, proceed. If so, please contact a contractor for assistance with installation.** Add framing to support the existing framing and edges of the Dome. If installing a light fixture with the Dome, add framing above the joists to support it.

FOR SUSPENDED CEILINGS:

Remove acoustical tiles and cut any necessary metal framework along the template. After installation, you will need to trim the tiles to fit, so that they are supported by the edge of the Dome.

INSTALLATION INSTRUCTIONS CONTINUED ON FOLLOWING PAGE.

- Ladder
- Tape Measure
- Framing Square
- Utility Knife or Heavy Duty Scissors
- Power Screwdriver/Drill
- Hammer
- Reciprocating Saw
- Crosscut Saw or Compound Miter Saw (for cutting frame)
- Corrosion-resistant Drywall Screws
- PL Premium Adhesive
- Pencil and/or Black Marker
- Spackle or Caulk
- Safety Glasses
- Construction Hanging Wire (for suspended ceiling systems)
- 2x4 and/or 2x6 Framing (as needed to frame the rough opening and/or create framing for any installed lighting fixtures)

USING CORROSION-RESISTANT FASTENERS AND PL PREMIUM ADHESIVE

Always use corrosion-resistant mechanical fasteners (nails or screws) and PL Premium Adhesive when installing Fypon products. This combination provides a secure, long lasting bond. Countersink all fasteners about 1/8 inch and fill with exterior grade white spackle. If desired, sand any minor imperfections and topcoat with a quality exterior latex or oil base paint. Fypon exterior millwork installations should be finished using a quality, exterior grade silicone caulk to prevent water infiltration behind siding, windows and doors. Some exterior millwork installations, in particular new construction (before siding is applied) may require a J-channel and/or flashing to prevent water infiltration. Installers must determine which installation technique is best for the specific situation.

IMPORTANT:

Please read these installation guidelines thoroughly before beginning installation. Please note that these guidelines are provided only to assist with the installation of Fypon mouldings and millwork products. Modified procedures may be required in order to meet specific situations, unique applications and local building codes. The manufacturer does not under any circumstances warrant the installation of its products. Be sure to wear appropriate protective clothing, gloves and safety glasses when working with any tools. Installer should check for and relocate all electrical wiring within the proposed installation area, as needed (be sure to disconnect all electric power before working with any electrical wiring and follow all applicable local electrical codes and safety procedures).

Domes (continued)

INSTALLATION INSTRUCTIONS

MATERIALS NEEDED



5. PREPARE THE DOME FOR INSTALLATION *(When used with lighting, or with suspended ceiling systems only - for all other installations, proceed to Step 6).*

To locate the center point of the Dome, use the side alignment marks. String, tape or lines drawn across the back of the Dome, using the alignment marks, will cross at the center point. At the center point, drill or cut the proper size hole in the Dome for any light fixture you will install. If using a jig saw or saber saw to cut the hole, drill a pilot hole and cut from the back to avoid chipping the edge of the hole. If installing into a suspended ceiling system, thread construction wire through the metal hanging straps on the back of the Dome. You will use these to suspend the Dome from the hangers used for the suspended ceiling system.

6. INSTALL DOME

Frame and Wallboard Construction: Apply an even bead of polyurethane construction adhesive on the inside of the Dome rim. Raise the Dome into position, and secure into the rough opening framing, driving non-corrosive fasteners (trim screws) up through the rim, through the ceiling and into the framing. Slightly countersink fasteners, so that you can cover the heads with spackle for a finished appearance. **Suspended Ceiling Construction:** Raise the Dome into position. Tie construction wires directly into the suspended ceiling hanger system to suspend the Dome. If installing a light fixture, you must support the fixture with additional framing that is properly attached to the ceiling or suspended ceiling support system. **Do not support the fixture by attaching it to the Dome.**

7. TOUCH UP AND PAINTING

Fill nail heads and any other minor imperfections with spackle (interior applications) or an exterior grade wood filler (exterior applications). After the filler has dried, sand any minor surface imperfections. Caulk or spackle where the Dome meets the ceiling, and finish with any quality latex or oil-based paint for a professional appearance.

Ladder
Tape Measure
Framing Square
Utility Knife or Heavy Duty Scissors
Power Screwdriver/Drill
Hammer
Reciprocating Saw
Crosscut Saw or Compound Miter Saw (for cutting frame)
Corrosion-resistant Drywall Screws
PL Premium Adhesive
Pencil and/or Black Marker
Spackle or Caulk
Safety Glasses
Construction Hanging Wire (for suspended ceiling systems)
2x4 and/or 2x6 Framing (as needed to frame the rough opening and/or create framing for any installed lighting fixtures)

USING CORROSION-RESISTANT FASTENERS AND PL PREMIUM ADHESIVE

Always use corrosion-resistant mechanical fasteners (nails or screws) and PL Premium Adhesive when installing Fypon products. This combination provides a secure, long lasting bond. Countersink all fasteners about 1/8 inch and fill with exterior grade white spackle. If desired, sand any minor imperfections and topcoat with a quality exterior latex or oil base paint. Fypon exterior millwork installations should be finished using a quality, exterior grade silicone caulk to prevent water infiltration behind siding, windows and doors. Some exterior millwork installations, in particular new construction (before siding is applied) may require a J-channel and/or flashing to prevent water infiltration. Installers must determine which installation technique is best for the specific situation.

IMPORTANT:

Please read these installation guidelines thoroughly before beginning installation. Please note that these guidelines are provided only to assist with the installation of Fypon mouldings and millwork products. Modified procedures may be required in order to meet specific situations, unique applications and local building codes. The manufacturer does not under any circumstances warrant the installation of its products. Be sure to wear appropriate protective clothing, gloves and safety glasses when working with any tools. Installer should check for and relocate all electrical wiring within the proposed installation area, as needed (be sure to disconnect all electric power before working with any electrical wiring and follow all applicable local electrical codes and safety procedures).

Niches

INSTALLATION INSTRUCTIONS
MATERIALS NEEDED

Note: All Fypon mouldings and millwork are installed using corrosion-resistant mechanical fasteners and PL Premium adhesive. See “Using Corrosion-resistant Fasteners and PL Premium Adhesive,” below, for details.

If your Niche comes fully assembled as a one-piece unit, proceed directly to the installation instructions. If your Niche requires assembly prior to final installation, see assembly instructions on page 31.

1. LOCATE STUDS

Use a stud finder or tap the wall, etc. to identify where the studs are in your wall. The Niche is designed to fit between the studs.

2. PLAN YOUR LAYOUT

Plan your layout carefully. You may want to cut a small pilot hole between the studs, in order to identify any electrical, plumbing or framing members that may be in the cavity behind the dry wall.

3. OUTLINE OPENING ON WALL

Use the rough opening dimensions provided to create a template for marking the rough opening on the wall. If you choose not to make a template, transfer the rough opening dimensions directly to the wall. Use a level as a straightedge to ensure the lines are plumb and level. **CAUTION:** Plan your layout carefully. Note that electrical, plumbing or framing members may be in the cavities behind the wall.

NICHE ROUGH OPENING SIZES				
Part Number	A	B	C	D
NCH18X30	14 1/2"	26"	4"	4"
NCH26X46	23 3/4"	41"	6 15/16"	6 15/16"
NCHS26X46	23 3/4"	41"	6 15/16"	6 15/16"
NCH34X62	26 1/4"	54 1/2"	7 1/4"	7 1/4"
NCHS34X62	26 1/4"	54 1/2"	7 1/4"	7 1/4"

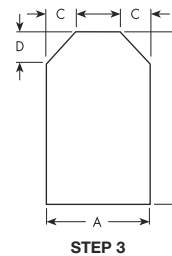
STEP 3

4. CUT THE HOLE

Cut the rough opening in the wall with a keyhole saw or reciprocating saw following the lines drawn in STEP 3.

5. APPLY ADHESIVE

Apply a bead of PL Premium Adhesive to the back of the Niche, where it contacts the wall.

6. SET NICHE INTO PLACE

Set the Niche into the opening and level it into place.

7. FASTEN NICHE INTO PLACE

Fasten the Niche into place using finishing nails or trim screws. Countersink the nails or screws.

8. COVER NAIL HEADS AND FINISH AS DESIRED

Cover the nail heads with spackle. When the spackle has dried, you can sand off any excess using very fine sandpaper. The Niche is now ready to be painted, stained or faux finished.

- Reciprocating Saw
- Ladder
- Tape Measure
- Hammer
- Corrosion-resistant Nails and Screws
- Nail Countersink
- Caulking Gun
- Paint Brush
- Safety Glasses
- Spackle
- Painter's Caulk
- Fine Sandpaper
- Latex or Oil Base Paint
- PL Premium Construction Adhesive

USING CORROSION-RESISTANT FASTENERS AND PL PREMIUM ADHESIVE

Always use corrosion-resistant mechanical fasteners (nails or screws) and PL Premium Adhesive when installing Fypon products. This combination provides a secure, long lasting bond. Countersink all fasteners about 1/8 inch and fill with exterior grade white spackle. If desired, sand any minor imperfections and topcoat with a quality exterior latex or oil base paint. Fypon exterior millwork installations should be finished using a quality, exterior grade silicone caulk to prevent water infiltration behind siding, windows and doors. Some exterior millwork installations, in particular new construction (before siding is applied) may require a J-channel and/or flashing to prevent water infiltration. Installers must determine which installation technique is best for the specific situation.

IMPORTANT:

Please read these installation guidelines thoroughly before beginning installation. Please note that these guidelines are provided only to assist with the installation of Fypon mouldings and millwork products. Modified procedures may be required in order to meet specific situations, unique applications and local building codes. The manufacturer does not under any circumstances warrant the installation of its products. Be sure to wear appropriate protective clothing, gloves and safety glasses when working with any tools. Installer should check for and relocate all electrical wiring within the proposed installation area, as needed (be sure to disconnect all electric power before working with any electrical wiring and follow all applicable local electrical codes and safety procedures).

Niche Assembly Instructions

INSTALLATION INSTRUCTIONS

NCH26X46 • NCHS26X46

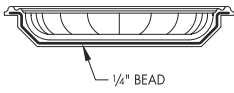

FIGURE 1

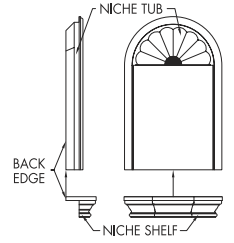

FIGURE 2



FIGURE 3

NCH34X62 • NCHS34X62

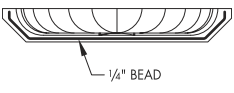

FIGURE 1A

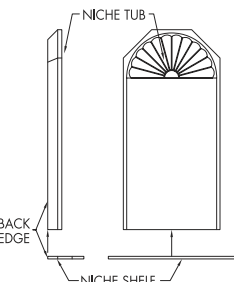

FIGURE 2A



FIGURE 3A

NCH26X46 • NCHS26X46

1. Apply a 1/4" bead of polyurethane construction adhesive along the bottom edge of the Niche tub (**SEE FIGURE 1**).
2. Apply the Niche shelf to the niche tub making sure that the back edges are even and the shelf is centered with the tub (**SEE FIGURE 2**).
3. Secure the shelf to the tub using drywall screws at the locations suggested (**SEE FIGURE 3**). The screws should be approximately 3/8" from the outside edge of the shelf. Make sure that the shelf does not move when driving the screws. Wipe off all excess adhesive and proceed to installation instructions.

Note: Any corrosion-resistant fastener may be used instead of drywall screws.

NCH34X62 • NCHS34X62

1. Apply a 1/4" bead of polyurethane construction adhesive along the bottom edge of the Niche tub (**SEE FIGURE 1A**).
2. Apply the Niche shelf to the niche tub making sure that the back edges are even and the shelf is centered with the tub (**SEE FIGURE 2A**).
3. Secure the shelf to the tub using drywall screws at the locations suggested (**SEE FIGURE 3A**). The screws should be approximately 3/8" from the outside edge of the shelf. Make sure that the shelf does not move when driving the screws. Wipe off all excess adhesive.
4. Apply a 1/4" bead of polyurethane construction adhesive along the top edge of the Niche tub (**SEE FIGURE 4**).
5. Secure the Niche trim to the tub using finishing nails at the locations suggested (**SEE FIGURE 5**). The finishing nails should be approximately 7/16" from the inside edge of the tub. Make sure that the trim does not move when driving the nails. Wipe off all excess adhesive.
6. Apply a 1/4" bead of polyurethane construction adhesive along the top edge of the Niche apron (**SEE FIGURE 6**).
7. Apply the Niche apron to the bottom side of the shelf making sure the back edge of the apron is even with the back edge of the shelf sides that protrude past the Niche tub. Secure the Niche apron to the shelf using drywall screws at the locations suggested (**SEE FIGURE 7**). Drive the screws through the top of the shelf and into the apron. Make sure that the apron does not move when driving the screws. Wipe off all excess adhesive. Proceed to installation instructions on page 30.

Note: Any corrosion-resistant fastener may be used instead of drywall screws.

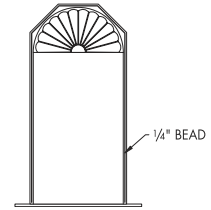

FIGURE 4

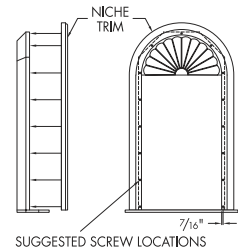

FIGURE 5

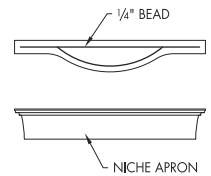

FIGURE 6

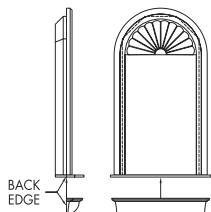
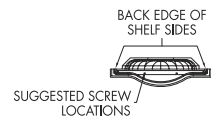

FIGURE 7

USING CORROSION-RESISTANT FASTENERS AND PL PREMIUM ADHESIVE

Always use corrosion-resistant mechanical fasteners (nails or screws) and PL Premium Adhesive when installing Fypon products. This combination provides a secure, long lasting bond. Countersink all fasteners about 1/8 inch and fill with exterior grade white spackle. If desired, sand any minor imperfections and topcoat with a quality exterior latex or oil base paint. Fypon exterior millwork installations should be finished using a quality, exterior grade silicone caulk to prevent water infiltration behind siding, windows and doors. Some exterior millwork installations, in particular new construction (before siding is applied) may require a J-channel and/or flashing to prevent water infiltration. Installers must determine which installation technique is best for the specific situation.

IMPORTANT:

Please read these installation guidelines thoroughly before beginning installation. Please note that these guidelines are provided only to assist with the installation of Fypon mouldings and millwork products. Modified procedures may be required in order to meet specific situations, unique applications and local building codes. The manufacturer does not under any circumstances warrant the installation of its products. Be sure to wear appropriate protective clothing, gloves and safety glasses when working with any tools. Installer should check for and relocate all electrical wiring within the proposed installation area, as needed (be sure to disconnect all electric power before working with any electrical wiring and follow all applicable local electrical codes and safety procedures).

5" Balustrade System

PARTS LIST

ITEM	QTY
A PORCH POST INSTALLATION KIT (PPK6) (SEE FIG. 3C)	
5 1/2" x 5 1/2" Trim Collar	2
2" Wide x 1 1/2" x 2" Angle Bracket	4
#14 x 2 1/2" Stainless Steel Flat Head Screw	12
B Porch Post (PP6X96)	
C Baluster Top Rail (BTR5X96 or BTR5X144)	
D Baluster	
E Baluster Bottom Rail (BBR5X96 or BBR5X144)	
F Rail Support Block (RSB4X4X6)	
G Post Top (PST7X7P shown or PST7X7F)	
H Newel Post (NP6X48)	
J BALUSTER RAIL INSTALLATION KIT (BRK5) (SEE FIG. 5A, 5B)	
2" Wide x 1 1/2" x 2" Angle Bracket	2
#14 x 2 1/2" Stainless Steel Flat Head Screw	6
K NEWEL POST INSTALLATION KIT (NPK6) (SEE FIG. 4A, 4B, 4C)	
3/8" - 16 Hex Nut	2
3/8" Lock Washer	2
3/8" USS Flat Washer	2
1/4" x 4 1/2" Diameter Steel Top Mounting Plate	1
3/8" - 16 x 50" Threaded Rod	2
1/4" x 3 1/2" x 3 1/2" Steel Base Plate <i>Note: Fasteners to mount Steel Base Plate to floor surface not provided.</i>	1
L OPTIONAL DECORATIVE TRIM COLLAR (TC6)	
5 1/2" x 5 1/2" Trim Collar	1

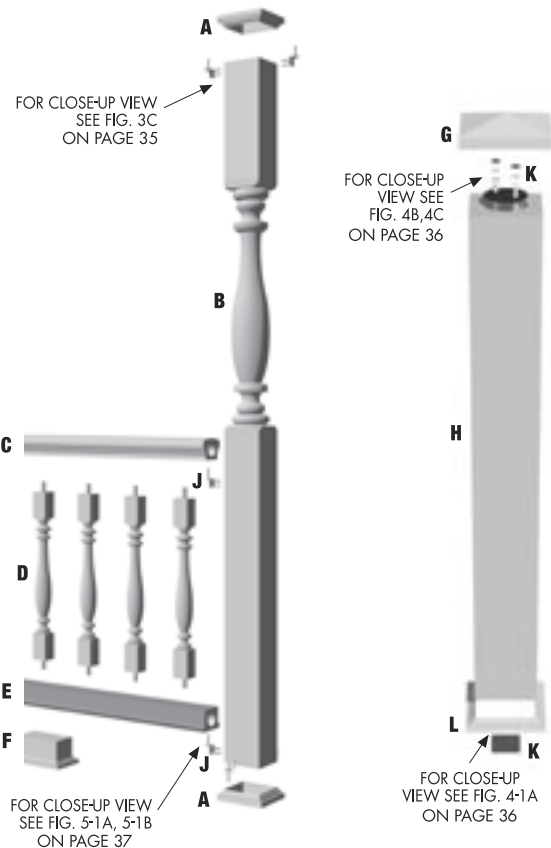

The 5" Balustrade System has been tested and meets the following BOCA National Building Code/1993 Criteria if assembled according to manufacturer's guidelines:

1615.8.2 Guard Design and Construction • 1615.8.2.1 In-Fill Areas

CHECK APPLICABLE BUILDING CODES since this procedure may require alterations to meet applicable building code regulations. The manufacturer does not, under any circumstances, warrant the **INSTALLATION** of its products. The installation guidelines are to be used as suggestions for successful installation.

USING CORROSION-RESISTANT FASTENERS AND PL PREMIUM ADHESIVE

Always use corrosion-resistant mechanical fasteners (nails or screws) and PL Premium Adhesive when installing Fypon products. This combination provides a secure, long lasting bond. Countersink all fasteners about 1/8 inch and fill with exterior grade white spackle. If desired, sand any minor imperfections and topcoat with a quality exterior latex or oil base paint. Fypon exterior millwork installations should be finished using a quality, exterior grade silicone caulk to prevent water infiltration behind siding, windows and doors. Some exterior millwork installations, in particular new construction (before siding is applied) may require a J-channel and/or flashing to prevent water infiltration. Installers must determine which installation technique is best for the specific situation.

IMPORTANT:

Please read these installation guidelines thoroughly before beginning installation. Please note that these guidelines are provided only to assist with the installation of Fypon mouldings and millwork products. Modified procedures may be required in order to meet specific situations, unique applications and local building codes. The manufacturer does not under any circumstances warrant the installation of its products. Be sure to wear appropriate protective clothing, gloves and safety glasses when working with any tools. Installer should check for and relocate all electrical wiring within the proposed installation area, as needed (be sure to disconnect all electric power before working with any electrical wiring and follow all applicable local electrical codes and safety procedures).

6" Balustrade System

PARTS LIST

ITEM	QTY
A PORCH POST INSTALLATION KIT (INCLUDED WITH PORCH POST, SEE FIG. 3C)	
Galvanized Column Mounting Plate	2
#14 x 2" Stainless Steel Sheet Metal Screw	4
B Porch Post (PP8X96) (Includes Installation Kit)	
C Baluster Top Rail (BTR6X96 or BTR6X144)	
D Baluster	
E Baluster Bottom Rail (BBR6X96 or BBR6X144)	
F Rail Support Block (RSB4X4X6)	
G Post Top (PST10X10P shown or PST10X10F)	
H Newel Post (NP8X48)	
J BALUSTER RAIL INSTALLATION KIT (BRK6-7) (SEE FIG. 5A, 5B)	
4" Wide x 1 1/2" x 2" Angle Bracket	2
#14 x 2 1/2" Stainless Steel Flat Head Screw	8
K NEWEL POST INSTALLATION KIT (NPK8) (SEE FIG. 4A, 4B, 4C)	
3/8" - 16 Hex Nut	2
3/8" Lock Washer	2
3/8" USS Flat Washer	2
1/4" x 6 1/2" Diameter Steel Top Mounting Plate	1
3/8" - 16 x 50" Threaded Rod	2
1/4" x 3 1/2" x 3 1/2" Steel Base Plate <i>Note: Fasteners to mount Steel Base Plate to floor surface not provided.</i>	1
L OPTIONAL DECORATIVE TRIM COLLAR (TC8)	
7 1/2" x 7 1/2" Trim Collar	

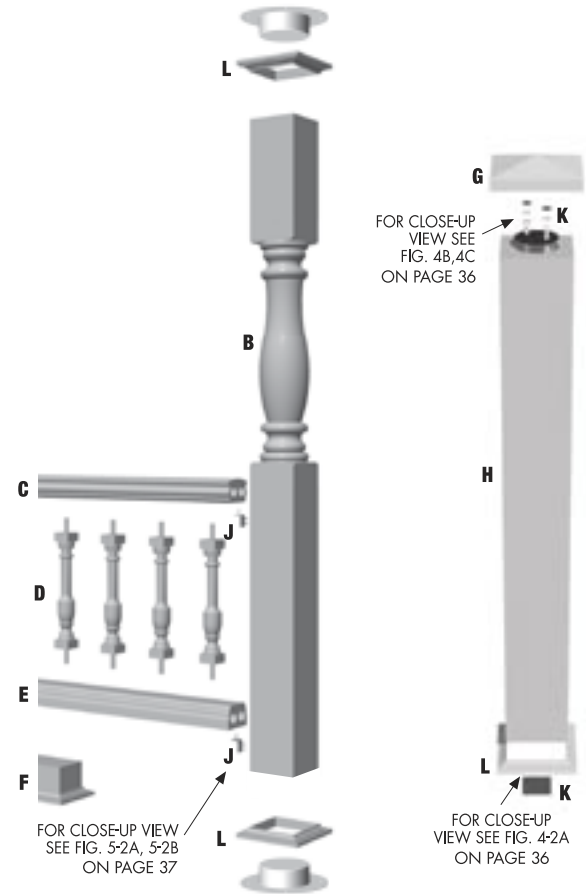

CHECK APPLICABLE BUILDING CODES since this procedure may require alterations to meet applicable building code regulations. The manufacturer does not, under any circumstances, warrant the INSTALLATION of its products. The installation guidelines are to be used as suggestions for successful installation.

USING CORROSION-RESISTANT FASTENERS AND PL PREMIUM ADHESIVE

Always use corrosion-resistant mechanical fasteners (nails or screws) and PL Premium Adhesive when installing Fypon products. This combination provides a secure, long lasting bond. Countersink all fasteners about 1/8 inch and fill with exterior grade white spackle. If desired, sand any minor imperfections and topcoat with a quality exterior latex or oil base paint. Fypon exterior millwork installations should be finished using a quality, exterior grade silicone caulk to prevent water infiltration behind siding, windows and doors. Some exterior millwork installations, in particular new construction (before siding is applied) may require a J-channel and/or flashing to prevent water infiltration. Installers must determine which installation technique is best for the specific situation.

IMPORTANT:

Please read these installation guidelines thoroughly before beginning installation. Please note that these guidelines are provided only to assist with the installation of Fypon mouldings and millwork products. Modified procedures may be required in order to meet specific situations, unique applications and local building codes. The manufacturer does not under any circumstances warrant the installation of its products. Be sure to wear appropriate protective clothing, gloves and safety glasses when working with any tools. Installer should check for and relocate all electrical wiring within the proposed installation area, as needed (be sure to disconnect all electric power before working with any electrical wiring and follow all applicable local electrical codes and safety procedures).

7" Balustrade System

PARTS LIST

ITEM	QTY
A PORCH POST INSTALLATION KIT (INCLUDED WITH PORCH POST, SEE FIG. 3C)	
Galvanized Column Mounting Plate	2
#14 x 2" Stainless Steel Sheet Metal Screw	4
B Porch Post (PP8X96) (Includes Installation Kit)	
C Baluster Top Rail (BTR7X96, BTR7X120 or BTR7X144)	
D Baluster	
E Baluster Bottom Rail (BBR7X96, BBR7X120 or BBR7X144)	
F Rail Support Block (RSB4X4X6)	
G Post Top (PST10X10P shown or PST10X10F)	
H Newel Post (NP8X48)	
J BALUSTER RAIL INSTALLATION KIT (BRK6-7) (SEE FIG. 5A, 5B)	
4" Wide x 1 1/2" x 2" Angle Bracket	2
#14 x 2 1/2" Stainless Steel Flat Head Screw	8
K NEWEL POST INSTALLATION KIT (NPK8) (SEE FIG. 4A, 4B, 4C)	
3/8" - 16 Hex Nut	2
3/8" Lock Washer	2
3/8" USS Flat Washer	2
1/4" x 6 1/2" Diameter Steel Top Mounting Plate	1
3/8" - 16 x 50" Threaded Rod	2
1/4" x 3 1/2" x 3 1/2" Steel Base Plate <i>Note: Fasteners to mount Steel Base Plate to floor surface not provided.</i>	1
L OPTIONAL DECORATIVE TRIM COLLAR (TC8)	
7 1/2" x 7 1/2" Trim Collar	

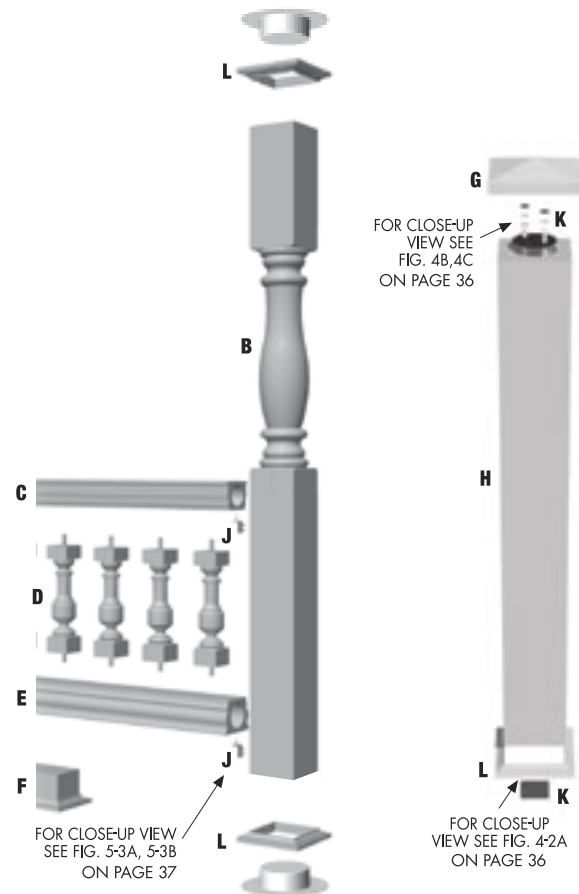

CHECK APPLICABLE BUILDING CODES since this procedure may require alterations to meet applicable building code regulations. The manufacturer does not, under any circumstances, warrant the INSTALLATION of its products. The installation guidelines are to be used as suggestions for successful installation.

USING CORROSION-RESISTANT FASTENERS AND PL PREMIUM ADHESIVE

Always use corrosion-resistant mechanical fasteners (nails or screws) and PL Premium Adhesive when installing Fypon products. This combination provides a secure, long lasting bond. Countersink all fasteners about 1/8 inch and fill with exterior grade white spackle. If desired, sand any minor imperfections and topcoat with a quality exterior latex or oil base paint. Fypon exterior millwork installations should be finished using a quality, exterior grade silicone caulk to prevent water infiltration behind siding, windows and doors. Some exterior millwork installations, in particular new construction (before siding is applied) may require a J-channel and/or flashing to prevent water infiltration. Installers must determine which installation technique is best for the specific situation.

IMPORTANT:

Please read these installation guidelines thoroughly before beginning installation. Please note that these guidelines are provided only to assist with the installation of Fypon mouldings and millwork products. Modified procedures may be required in order to meet specific situations, unique applications and local building codes. The manufacturer does not under any circumstances warrant the installation of its products. Be sure to wear appropriate protective clothing, gloves and safety glasses when working with any tools. Installer should check for and relocate all electrical wiring within the proposed installation area, as needed (be sure to disconnect all electric power before working with any electrical wiring and follow all applicable local electrical codes and safety procedures).

5", 6" and 7" Balustrade Systems

INSTALLATION INSTRUCTIONS



1. INITIAL LAYOUT

Mark layout lines on floor surface where all PORCH POSTS and NEWEL POSTS will be located. Allow dimensions for the layout of both NEWEL POSTS and PORCH POSTS.

Note: This layout is important in order to get accurate measurements for the actual length of each TOP and BOTTOM RAIL.

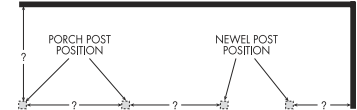

STEP 1

2. BUILD UP AND ASSEMBLE RAIL SECTIONS

To speed up field installations, build up and assemble the BALUSTRADE RAIL SECTIONS in a shop setting when possible. Follow up with easy installation between the supporting posts out on the job site.

- A) Using accurate field measurements (taken in Step 1) cut the matching TOP and BOTTOM RAILS to length for each respective section.
- B) Lay out and mark center lines on RAILS. Mark BALUSTER positions then drill holes to accept BALUSTERS. The diameter of the drilled holes will vary according to the BALUSTRADE size. Tip: A drill press with standard woodworking drill bits works well for drilling these holes.
- C) Apply a 1/4" bead of urethane base construction adhesive on each end of BALUSTER. Then insert BALUSTER into the drilled TOP and BOTTOM RAIL.
- D) Lay the RAIL ASSEMBLY on a flat surface. Use strap clamps as needed to draw RAIL ASSEMBLY together. Clamp tightly and allow the adhesive to set up. (This usually takes a minimum of 12 hours.) As the RAIL ASSEMBLY is drying, before it sets up, make sure it is square and that the BALUSTERS are square to the RAIL SECTION. Clean off any excess adhesive with a putty knife before the adhesive sets. Do not handle the newly assembled RAIL SECTIONS until the adhesive has cured completely. If painting is desired, a good time to paint the RAIL SECTIONS would be now, before field assembly begins.



STEP 2C



STEP 2D

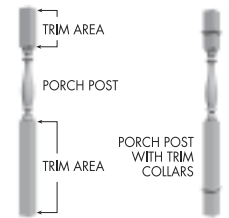

STEP 3B

3. INSTALL PORCH POSTS

FOR PP6X96 ONLY A) The PORCH POST is a load bearing support post. It can be trimmed to various heights in the top or bottom flat post areas without affecting the integrity of the POST. However, the PORCH POST has a steel pipe molded into the center which must be cut with a hack saw or Sawzall® reciprocating saw with metal cutting blades.

B) Slide TRIM COLLARS along POST.

C) Install the 2" wide x 1 1/2" x 2" angle brackets as shown in Fig. 3C. Drill 1/8" x 2 1/2" pilot hole for #14 x 2 1/2" stainless steel flat head screws. (Masonry fasteners not included.) Then slide TRIM COLLARS over the brackets. Secure with adhesive and trim nails.

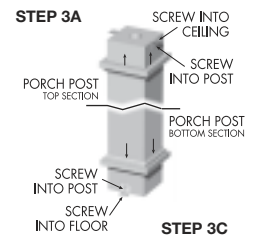

STEP 3C

FOR PP8X96 ONLY A) Determine the required height of the PORCH POST by carefully measuring the distance from the floor to the bottom of the porch overhang or other structure being supported.

B) Fypon PORCH POST are trimmed for height at the bottom. Transfer the measurement from Step One, above, marking all the way around the base of the POST. Carefully cut the polymer shell of the POST using a circular saw or hand saw, being careful to not cut into the steel reinforcement. Then cut through the steel reinforcement using a hack saw or power reciprocating saw with a steel cutting blade.

INSTALLATION INSTRUCTIONS CONTINUED ON FOLLOWING PAGE.

USING CORROSION-RESISTANT FASTENERS AND PL PREMIUM ADHESIVE

Always use corrosion-resistant mechanical fasteners (nails or screws) and PL Premium Adhesive when installing Fypon products. This combination provides a secure, long lasting bond. Countersink all fasteners about 1/8 inch and fill with exterior grade white spackle. If desired, sand any minor imperfections and topcoat with a quality exterior latex or oil base paint. Fypon exterior millwork installations should be finished using a quality, exterior grade silicone caulk to prevent water infiltration behind siding, windows and doors. Some exterior millwork installations, in particular new construction (before siding is applied) may require a J-channel and/or flashing to prevent water infiltration. Installers must determine which installation technique is best for the specific situation.

IMPORTANT:

Please read these installation guidelines thoroughly before beginning installation. Please note that these guidelines are provided only to assist with the installation of Fypon mouldings and millwork products. Modified procedures may be required in order to meet specific situations, unique applications and local building codes. The manufacturer does not under any circumstances warrant the installation of its products. Be sure to wear appropriate protective clothing, gloves and safety glasses when working with any tools. Installer should check for and relocate all electrical wiring within the proposed installation area, as needed (be sure to disconnect all electric power before working with any electrical wiring and follow all applicable local electrical codes and safety procedures).

5", 6" and 7" Balustrade Systems (continued)

INSTALLATION INSTRUCTIONS



- C)** After cutting through the steel tubing, pre-drill holes approximately 3/4" up from the bottom of the POST using a 13/64" drill bit. These holes should enter the side of the POST at a right angle and go through both the polymer shell and the steel reinforcement. Now use a 1/2" drill bit to expand the drill holes through the polymer only (do not drill through the steel reinforcement) using the 13/64" holes as pilot holes. These 1/2" holes will allow the screw head to go all the way to the steel reinforcement. Repeat this process at the top of the POST, pre-drilling holes approximately 3/4" from the top and centered on the top side.
- D)** Paint all exposed steel at both the top and bottom of the POST, using a quality, zinc base primer spray paint (Rust-Oleum®, etc.) to help prevent corrosion.
- E)** Determine the proper location for top and bottom column mounting plates. Be careful to mark these locations precisely, so that the top and bottom plates line up directly above and below each other. Identify the correct location of the top plate first, and use a plumb line dropped from the center point of the top plate location to accurately align the center point location for the bottom column mounting plate.
- F)** Install the top and bottom column mounting plates using corrosion resistant mechanical fasteners. For anchoring into wooden floors, ceilings and other structures, stainless steel flat head screws are recommended. For installation into concrete, stone or other floor and ceiling materials, appropriate masonry and/or other fasteners must be used.
- G)** Set the POST into place beneath the top anchor. Lift (jack) the upper structure just high enough to allow the POST to be set into place above the bottom anchor.
- H)** Use the 13/64" holes drilled in Step 3 as guide holes to drill 13/64" holes through the column mounting plates. Firmly attach the POST to the top and bottom plates, driving the corrosion resistant screws provided all the way in so that their heads are flush against the steel tubing (four screws provided, two for the top plate and two for the bottom).
- I)** Patch screw holes using a quality exterior grade, non-shrinking wood filler. Once the filler has dried, lightly sand any minor imperfections and paint the POST as desired using a quality exterior grade latex or oil base paint.

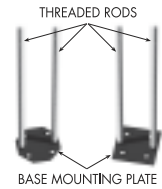

STEP 4A

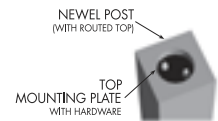

STEP 4B

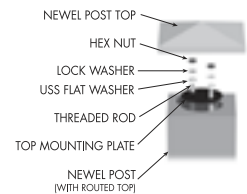

STEP 4C

4. INSTALL NEWEL POSTS

- A)** Center the steel BASE MOUNTING PLATE within layout lines marked out in Step 1. Mount them securely to floor surface (fasteners to mount to floor surface not provided). Install and tighten the two 3/8" - 16 x 50" THREADED RODS into MOUNTING PLATE.
- B)** The NEWEL POST may be trimmed to a desired height (measure and cut from the unrouted end of the POST). Add a centered saw kerf to the bottom of the newel post for water drainage. To install the POST align the POST over the THREADED RODS. Install the steel TOP MOUNTING PLATE over the THREADED RODS into the recessed cavity of the NEWEL POST TOP which is routed to accept the hardware. Install 3/8" flat and lock washers and tighten with 3/8" nuts to 100 in./lbs. torque.
- C)** TRIM COLLARS may be used on the bottom of the NEWEL POSTS to add a finishing touch. (SEE PARTS LISTS.) Slide the COLLARS over the top of the NEWEL POST into position before the NEWEL POST TOP is fastened in place.
- D)** Finish NEWEL POST by attaching NEWEL POST TOP. Apply urethane base

INSTALLATION INSTRUCTIONS CONTINUED ON FOLLOWING PAGE.

USING CORROSION-RESISTANT FASTENERS AND PL PREMIUM ADHESIVE

Always use corrosion-resistant mechanical fasteners (nails or screws) and PL Premium Adhesive when installing Fypon products. This combination provides a secure, long lasting bond. Countersink all fasteners about 1/8 inch and fill with exterior grade white spackle. If desired, sand any minor imperfections and topcoat with a quality exterior latex or oil base paint. Fypon exterior millwork installations should be finished using a quality, exterior grade silicone caulk to prevent water infiltration behind siding, windows and doors. Some exterior millwork installations, in particular new construction (before siding is applied) may require a J-channel and/or flashing to prevent water infiltration. Installers must determine which installation technique is best for the specific situation.

IMPORTANT:

Please read these installation guidelines thoroughly before beginning installation. Please note that these guidelines are provided only to assist with the installation of Fypon mouldings and millwork products. Modified procedures may be required in order to meet specific situations, unique applications and local building codes. The manufacturer does not under any circumstances warrant the installation of its products. Be sure to wear appropriate protective clothing, gloves and safety glasses when working with any tools. Installer should check for and relocate all electrical wiring within the proposed installation area, as needed (be sure to disconnect all electric power before working with any electrical wiring and follow all applicable local electrical codes and safety procedures).

5", 6" and 7" Balustrade Systems (continued)

INSTALLATION INSTRUCTIONS

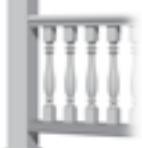

STEP 5

5-1. INSTALL 5" RAIL SECTIONS

With all POSTS in position, screw ANGLE BRACKETS to the POST or wall surface. Drill 1/8" x 2 1/2" pilot hole for screws. The RAIL ASSEMBLY is positioned snugly between the POSTS and secured in place using the same ANGLE BRACKETS. This step requires three stainless steel flat head screws (#14 x 2 1/2").

A) Determine height of RAIL and fasten top ANGLE BRACKET securely to POST using two screws.

B) Fasten bottom ANGLE BRACKET to underside of RAIL SECTION using one screw.

C) Apply urethane base construction adhesive to the ends of RAIL that come in contact with POST. Position RAIL ASSEMBLY between POST and install remaining screws.

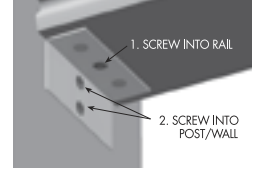

STEP 5-3A

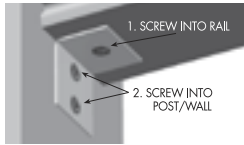

STEP 5-1A



STEP 5-1B

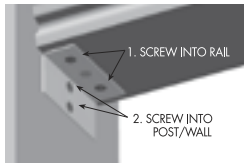

STEP 5-2A

5-2. INSTALL 6" RAIL SECTIONS

With all POSTS in position, screw ANGLE BRACKETS to the POST or wall surface. Drill 1/8" x 2 1/2" pilot hole for screws. The RAIL ASSEMBLY is positioned snugly between the POSTS and secured in place using the same ANGLE BRACKETS. This step requires three stainless steel flat head screws (#14 x 2 1/2").

A) Determine height of RAIL and fasten top ANGLE BRACKET securely to POST using two screws.

B) Fasten bottom ANGLE BRACKET to underside of RAIL SECTION using one screw.

C) Apply urethane base construction adhesive to the ends of RAIL that come in contact with POST. Position RAIL ASSEMBLY between POST and install remaining screws.

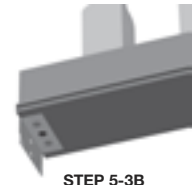

STEP 5-3B

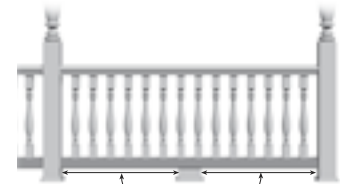

STEP 6

5-3. INSTALL 7" RAIL SECTIONS

With all POSTS in position, screw ANGLE BRACKETS to the POST or wall surface. Drill 1/8" x 2 1/2" pilot hole for screws. The RAIL ASSEMBLY is positioned snugly between the POSTS and secured in place using the same ANGLE BRACKETS. This step requires three stainless steel flat head screws (#14 x 2 1/2").

A) Determine height of RAIL and fasten top ANGLE BRACKET securely to POST using two screws.

B) Fasten bottom ANGLE BRACKET to underside of RAIL SECTION using one screw.

C) Apply urethane base construction adhesive to the ends of RAIL that come in contact with POST. Position RAIL ASSEMBLY between POST and install remaining screws.

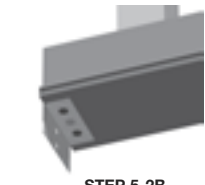

STEP 5-2B

6. RAIL SUPPORT BLOCKS

RAIL SUPPORT BLOCKS should be placed under the BOTTOM RAIL at a span of every 48" or less. These blocks can be trimmed for height.

7. FINISHING

All exposed fastener heads should be countersunk and filled with automotive body filler (example: Bondo). Allow filler to cure then sand flush to the millwork surface. Caulk any gaps with a good quality exterior caulk any good quality latex or oil base paint can be applied over the factory finish.

USING CORROSION-RESISTANT FASTENERS AND PL PREMIUM ADHESIVE

Always use corrosion-resistant mechanical fasteners (nails or screws) and PL Premium Adhesive when installing Fypon products. This combination provides a secure, long lasting bond. Countersink all fasteners about 1/8 inch and fill with exterior grade white spackle. If desired, sand any minor imperfections and topcoat with a quality exterior latex or oil base paint. Fypon exterior millwork installations should be finished using a quality, exterior grade silicone caulk to prevent water infiltration behind siding, windows and doors. Some exterior millwork installations, in particular new construction (before siding is applied) may require a J-channel and/or flashing to prevent water infiltration. Installers must determine which installation technique is best for the specific situation.

IMPORTANT:

Please read these installation guidelines thoroughly before beginning installation. Please note that these guidelines are provided only to assist with the installation of Fypon mouldings and millwork products. Modified procedures may be required in order to meet specific situations, unique applications and local building codes. The manufacturer does not under any circumstances warrant the installation of its products. Be sure to wear appropriate protective clothing, gloves and safety glasses when working with any tools. Installer should check for and relocate all electrical wiring within the proposed installation area, as needed (be sure to disconnect all electric power before working with any electrical wiring and follow all applicable local electrical codes and safety procedures).

12" Balustrade System

PARTS LIST

ITEM	QTY
(SEE FIG. EX1)	
A Newel Post Top (PST13X13F, PST13X13P, PST14X14P, PST14X14F)	
B Newel Post Top Section (NP12X48)	
C Newel Post Center Section (NP12X48)	
D Newel Post Bottom Section (NP12X48)	
E Baluster Top Rail (BTR12X96 or BTR12X120)	
F Baluster Bottom Rail (BBR12X96 or BBR12X120)	
G Baluster	
BALUSTER RAIL INSTALLATION KIT (BRK12) (SEE FIG. EX2) <i>Parts for mounting rails to wall (See Page 176)</i>	
Bear Claw Bracket	4
5/16" - 18 Clip Nut	4
#12 x 3/4" Pan Head Screw	16
5/16" - 18 x 5" Hex Head Cap Screw	4
5/16" x 1 1/2" Fender Washer	4
1/4" - 20 x 2" Flat Head Self Tapping Screw	4
NEWEL POST INSTALLATION KIT (NPK12) (SEE FIG. EX3)	
3/8" - 16 Hex Nut	2
3/8" Lock Washer	2
3/8" USS Flat Washer	2
Corner Bracket	2
3/8" - 16 x 39" Threaded Rod	2
#10 x 3/4" Flat Head Self Tapping Screw	8
1/4" x 7" x 7" Steel Base Plate (See Fig. EX1) <i>Note: Fasteners to mount Steel Base Plate to floor surface not provided.</i>	1

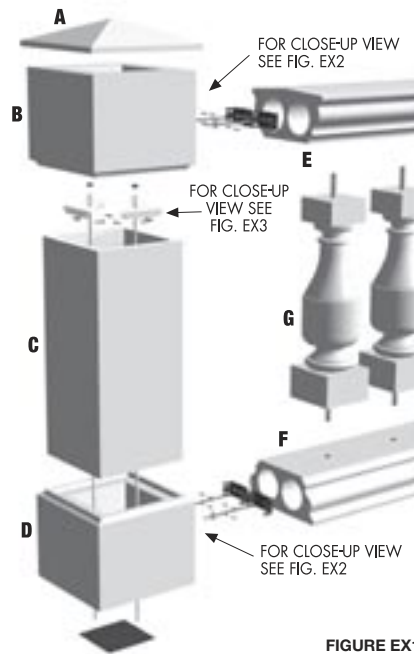

FIGURE EX1



FIGURE EX2



FIGURE EX3

CHECK APPLICABLE BUILDING CODES since this procedure may require alterations to meet applicable building code regulations. The manufacturer does not, under any circumstances, warrant the **INSTALLATION** of its products. The installation guidelines are to be used as suggestions for successful installation.

USING CORROSION-RESISTANT FASTENERS AND PL PREMIUM ADHESIVE

Always use corrosion-resistant mechanical fasteners (nails or screws) and PL Premium Adhesive when installing Fypon products. This combination provides a secure, long lasting bond. Countersink all fasteners about 1/8 inch and fill with exterior grade white spackle. If desired, sand any minor imperfections and topcoat with a quality exterior latex or oil base paint. Fypon exterior millwork installations should be finished using a quality, exterior grade silicone caulk to prevent water infiltration behind siding, windows and doors. Some exterior millwork installations, in particular new construction (before siding is applied) may require a J-channel and/or flashing to prevent water infiltration. Installers must determine which installation technique is best for the specific situation.

IMPORTANT:

Please read these installation guidelines thoroughly before beginning installation. Please note that these guidelines are provided only to assist with the installation of Fypon mouldings and millwork products. Modified procedures may be required in order to meet specific situations, unique applications and local building codes. The manufacturer does not under any circumstances warrant the installation of its products. Be sure to wear appropriate protective clothing, gloves and safety glasses when working with any tools. Installer should check for and relocate all electrical wiring within the proposed installation area, as needed (be sure to disconnect all electric power before working with any electrical wiring and follow all applicable local electrical codes and safety procedures).

12" Balustrade System

INSTALLATION INSTRUCTIONS

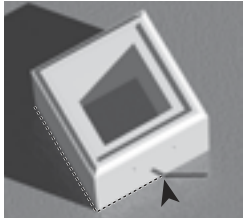

FIGURE 1A

1. INITIAL LAYOUT

A) Temporarily position NEWEL POST BOTTOM SECTIONS and mark layout lines on floor surface (**FIG. 1A**). This positioning is important in order to get accurate measurements between the NEWEL POST BOTTOM SECTIONS.

NOTE: This will give you the actual cut lengths of the BALUSTER TOP and BOTTOM RAILS.

B) Measure the distance between each of the NEWEL POST BOTTOM SECTIONS (**FIG. 1B**), and cut respective lengths of BALUSTER RAILING to be installed between the NEWEL POST BOTTOM SECTIONS. Add a centered saw kerf to the bottom of the newel post for water drainage.

NOTE: While measuring and cutting BALUSTER BOTTOM RAILS, cut matching length TOP RAILS to be installed in a later step.

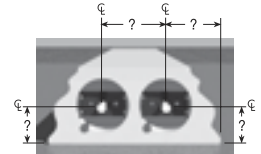

FIGURE 4A



FIGURE 1B

2. ANCHORING STEEL BASE PLATES

Center STEEL BASE PLATES inside layout lines from Step 1A above, and anchor each STEEL BASE PLATE to an adequate mounting surface (**FIG. 2A**). These will anchor the NEWEL POSTS.

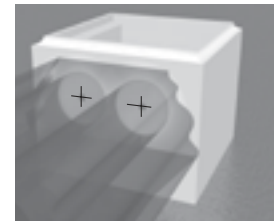

FIGURE 4B

3. INSTALLING BEAR CLAW BRACKETS

Select a cut-to-length BALUSTER BOTTOM RAIL.

Install 5/16" - 18 CLIP NUTS on BEAR CLAW BRACKETS. (**SEE FIG. EX2 ON PAGE 171 FOR DETAILED VISUAL.**) Position BEAR CLAW BRACKETS flush with the of the BALUSTER BOTTOM RAIL, and predrill 5/32" holes. Fasten BEAR CLAW BRACKETS using #12 x 3/4" PAN HEAD SCREWS provided. Position the screws as close as possible to the front of elongated slots in the BEAR CLAW BRACKETS (**FIG. 3A**).

NOTE: Repeat this step for corresponding BALUSTER TOP RAILS.

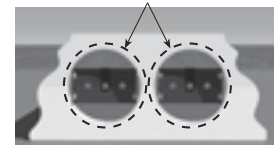

FIGURE 4C



FIGURE 2A

4. MOUNTING BOTTOM RAIL

A) Temporarily thread a 5/16" - 18 x 5" HEX HEAD CAP SCREW into center of the BEAR CLAW BRACKET and record the indicated center line measurements (**FIG. 4A**).

B) Transfer the measurements onto the NEWEL POST BOTTOM SECTION that will come in contact with the BALUSTER BOTTOM RAIL (**FIG. 4B**), and drill 1/2" holes, which are oversize, in the NEWEL POST BOTTOM SECTION.

NOTE: The position of these holes will determine the height that the BALUSTER BOTTOM RAIL will be raised above the mounting surface.

For installations where BALUSTER BOTTOM RAIL is raised off of mounting surface, blocking is recommended with a RAIL SUPPORT BLOCK (RSB4X4X6) every 4' or less.

NEWEL POST components can be trimmed to achieve custom NEWEL POST heights.
Note: The BALUSTER height is not adjustable.

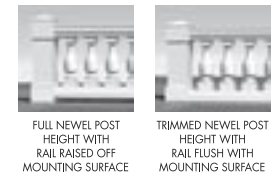

FULL NEWEL POST HEIGHT WITH RAIL RAISED OFF MOUNTING SURFACE
TRIMMED NEWEL POST HEIGHT WITH RAIL FLUSH WITH MOUNTING SURFACE



FIGURE 3A

C) Apply a 1/4" bead of urethane base adhesive on each end of the BALUSTER BOTTOM RAIL (**FIG. 4C**).

D) Position the BALUSTER BOTTOM RAIL between the NEWEL POST BOTTOM SECTIONS and align the 5/16" - 18 x 5" HEX HEAD CAP SCREWS with the BEAR CLAW BRACKETS (Fig. 4D). Be sure to check that the BALUSTER BOTTOM RAIL is level. Tighten 5/16"-18 x 5" HEX HEAD CAP SCREWS to 75 in./lbs. torque. Repeat Step 4 around the entire balustrade layout.

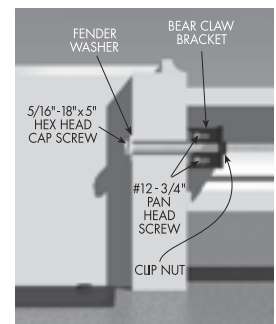

FIGURE 4D

INSTALLATION INSTRUCTIONS CONTINUED ON FOLLOWING PAGE.

USING CORROSION-RESISTANT FASTENERS AND PL PREMIUM ADHESIVE

Always use corrosion-resistant mechanical fasteners (nails or screws) and PL Premium Adhesive when installing Fypon products. This combination provides a secure, long lasting bond. Countersink all fasteners about 1/8 inch and fill with exterior grade white spackle. If desired, sand any minor imperfections and topcoat with a quality exterior latex or oil base paint. Fypon exterior millwork installations should be finished using a quality, exterior grade silicone caulk to prevent water infiltration behind siding, windows and doors. Some exterior millwork installations, in particular new construction (before siding is applied) may require a J-channel and/or flashing to prevent water infiltration. Installers must determine which installation technique is best for the specific situation.

IMPORTANT:

Please read these installation guidelines thoroughly before beginning installation. Please note that these guidelines are provided only to assist with the installation of Fypon mouldings and millwork products. Modified procedures may be required in order to meet specific situations, unique applications and local building codes. The manufacturer does not under any circumstances warrant the installation of its products. Be sure to wear appropriate protective clothing, gloves and safety glasses when working with any tools. Installer should check for and relocate all electrical wiring within the proposed installation area, as needed (be sure to disconnect all electric power before working with any electrical wiring and follow all applicable local electrical codes and safety procedures).

12" Balustrade System (continued)

INSTALLATION INSTRUCTIONS



5. PREPARING RAILS FOR BALUSTERS

NOTE: Check applicable building codes concerning regulations on distance between BALUSTERS.

With the BALUSTER BOTTOM RAIL in place, lay out and mark center lines for the BALUSTERS. After marking BALUSTER positions, drill 1 1/8" holes to 3" deep to accept BALUSTERS (**FIG 5A**).

TIP: While laying out and drilling BALUSTER BOTTOM RAIL system, also lay out and drill matching BALUSTER TOP RAILS.

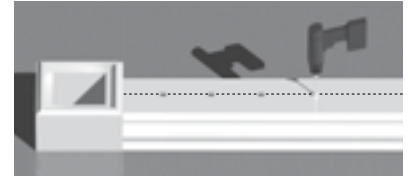

FIGURE 5A

6. PREPARING NEWEL POST FOR BALUSTERS

A) Install and tighten the two 3/8" - 16 x 39" THREADED RODS into the STEEL BASE PLATE assemblies (Fig. 6A).

B) Install the two STEEL CORNER BRACKETS inside the NEWEL POST TOP SECTION using the #10 x 3/4" FLAT HEAD SELF TAPPING SCREWS provided (Fig 6B). *NOTE: Align diagonally to match THREADED RODS.*

C) Temporarily position BALUSTERS on each end of BALUSTER BOTTOM RAIL. Temporarily position BALUSTER TOP RAIL and the remaining NEWEL POST components to visualize and determine height of the NEWEL POST (Fig. 6C). If the NEWEL POST is too high, the TOP SECTION, CENTER SECTION and/or BOTTOM SECTION of the NEWEL POST can be trimmed.

NOTE: The BALUSTER height is not adjustable.

D) Once the height of the NEWEL POST has been determined, trim (if required) all the NEWEL POST SECTIONS to the same height.

E) As in Step 4B, lay out and drill the 1/2" holes into each NEWEL POST TOP SECTION where they will contact the BALUSTER TOP RAIL.

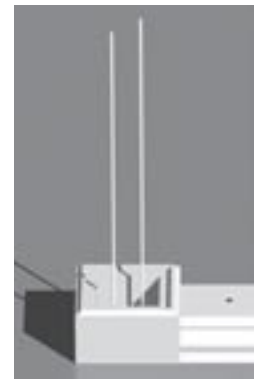

FIGURE 6A



FIGURE 6B

INSTALLATION INSTRUCTIONS CONTINUED ON FOLLOWING PAGE.

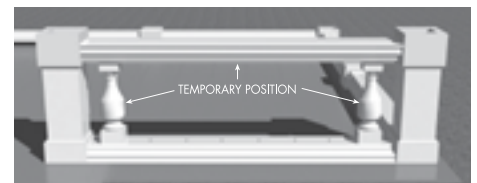

FIGURE 6C

USING CORROSION-RESISTANT FASTENERS AND PL PREMIUM ADHESIVE

Always use corrosion-resistant mechanical fasteners (nails or screws) and PL Premium Adhesive when installing Fypon products. This combination provides a secure, long lasting bond. Countersink all fasteners about 1/8 inch and fill with exterior grade white spackle. If desired, sand any minor imperfections and topcoat with a quality exterior latex or oil base paint. Fypon exterior millwork installations should be finished using a quality, exterior grade silicone caulk to prevent water infiltration behind siding, windows and doors. Some exterior millwork installations, in particular new construction (before siding is applied) may require a J-channel and/or flashing to prevent water infiltration. Installers must determine which installation technique is best for the specific situation.

IMPORTANT:

Please read these installation guidelines thoroughly before beginning installation. Please note that these guidelines are provided only to assist with the installation of Fypon mouldings and millwork products. Modified procedures may be required in order to meet specific situations, unique applications and local building codes. The manufacturer does not under any circumstances warrant the installation of its products. Be sure to wear appropriate protective clothing, gloves and safety glasses when working with any tools. Installer should check for and relocate all electrical wiring within the proposed installation area, as needed (be sure to disconnect all electric power before working with any electrical wiring and follow all applicable local electrical codes and safety procedures).

12" Balustrade System (continued)

INSTALLATION INSTRUCTIONS



FIGURE 7A

7. FINAL ASSEMBLY

With all NEWEL POSTS prepared for correct height you are ready for the final assembly.

A) Position the NEWEL POST BOTTOM SECTION in final alignment with the floor layout lines marked in Step 1A. Apply a 1/4" bead of urethane base adhesive to the channel in NEWEL POST BOTTOM SECTION, and stack NEWEL POST CENTER SECTION onto NEWEL POST BOTTOM SECTION.

B) Working with one section at a time, apply a 1/4" bead of urethane base adhesive on both ends of each BALUSTER (**FIG. 7A**).

C) Position a BALUSTER into each predrilled hole in the BALUSTER BOTTOM RAIL assembly. Align and cap off with predrilled BALUSTER TOP RAIL assembly (**FIG. 7B**).

TIP: To keep all the BALUSTERS in alignment during assembly, clamp a temporary straight edge on one edge of the BALUSTER BOTTOM RAIL.

D) Apply a 1/4" bead of urethane base adhesive to BALUSTER TOP RAIL ends and to the channel in NEWEL POST TOP SECTION. Carefully stack NEWEL POST TOP SECTION onto NEWEL POST CENTER SECTION.

E) Fasten the 5/16" - 18 x 5" HEX HEAD CAP SCREWS into the BEAR CLAW BRACKETS in the BALUSTER TOP RAIL and tighten to 75 in./lbs. torque.

F) Install a 3/8" USS FLAT WASHER, a 3/8" LOCK WASHER and a 3/8" - 16 HEX NUT onto the THREADED ROD assembly. Tighten the entire assembly to 100 in./lbs. torque (**FIG. 7C**). This step may be completed after entire assembly process, or as each section is completed.

G) Apply caulk to seam in channels of NEWEL POST assembly to prevent moisture infiltration (**FIG. 7D**).

H) Apply a 1/4" bead of urethane base adhesive to NEWEL POST TOP SECTION, and then install NEWEL POST TOP (**FIG. 7D**).



FIGURE 7E

TIP: How to dress up that NEWEL POST. Mouldings such as MLD601, MLD602, MLD610 and MLD611 may be applied to NEWEL POST CENTER SECTION as a decorative treatment. Just miter corners and fasten with a 1/4" bead of urethane base adhesive and noncorrosive fasteners (Fig. 7E).

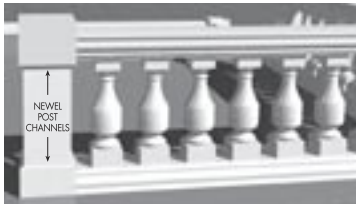

FIGURE 7B



FIGURE 7C

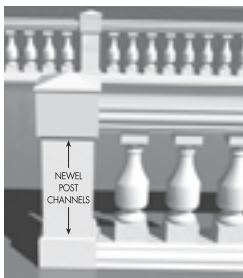

FIGURE 7D

INSTALLATION INSTRUCTIONS CONTINUED ON FOLLOWING PAGE.

USING CORROSION-RESISTANT FASTENERS AND PL PREMIUM ADHESIVE

Always use corrosion-resistant mechanical fasteners (nails or screws) and PL Premium Adhesive when installing Fypon products. This combination provides a secure, long lasting bond. Countersink all fasteners about 1/8 inch and fill with exterior grade white spackle. If desired, sand any minor imperfections and topcoat with a quality exterior latex or oil base paint. Fypon exterior millwork installations should be finished using a quality, exterior grade silicone caulk to prevent water infiltration behind siding, windows and doors. Some exterior millwork installations, in particular new construction (before siding is applied) may require a J-channel and/or flashing to prevent water infiltration. Installers must determine which installation technique is best for the specific situation.

IMPORTANT:

Please read these installation guidelines thoroughly before beginning installation. Please note that these guidelines are provided only to assist with the installation of Fypon mouldings and millwork products. Modified procedures may be required in order to meet specific situations, unique applications and local building codes. The manufacturer does not under any circumstances warrant the installation of its products. Be sure to wear appropriate protective clothing, gloves and safety glasses when working with any tools. Installer should check for and relocate all electrical wiring within the proposed installation area, as needed (be sure to disconnect all electric power before working with any electrical wiring and follow all applicable local electrical codes and safety procedures).

12" Balustrade System (continued)

INSTALLATION INSTRUCTIONS



WALL INSTALLATION

NOTE: The fasteners for mounting BEAR CLAW BRACKETS to the wall are not included in the BALUSTER RAIL INSTALLATION KIT.

- A)** Determine position of BALUSTER BOTTOM RAIL and mark layout on wall. Locate position of center of BEAR CLAW BRACKETS on wall. Mount BEAR CLAW BRACKETS securely to wall (fasteners for this are not included in hardware pack). See illustration above for orientation of BEAR CLAW BRACKET.
- B)** Apply a 1/4" bead of urethane base adhesive on the end of BALUSTER BOTTOM RAIL and position BALUSTER BOTTOM RAIL over BEAR CLAW BRACKETS and flush with the wall. Drill a 7/32" pilot hole from the top of the BALUSTER BOTTOM RAIL into center of each BEAR CLAW BRACKET. Secure with 1/4" - 20 x 2" FLAT HEAD SELF TAPPING SCREWS (provided with BALUSTER RAIL INSTALLATION KIT).
- C)** Position and install BALUSTERS using the steps described previously in these guidelines. Use above procedures to attach BALUSTER TOP RAIL to wall.

NOTE: When working with wall installations, fasten the BALUSTER RAILS to the wall first, then assemble away from wall sections!



The 12" Balustrade System has been tested and meets the following BOCA National Building Code/1993 Criteria if assembled according to manufacturer's guidelines:

1615.8.2 Guard Design and Construction • 1615.8.2.1 In-Fill Areas

CHECK APPLICABLE BUILDING CODES since this procedure may require alterations to meet applicable building code regulations. The manufacturer does not, under any circumstances, warrant the INSTALLATION of its products. The installation guidelines are to be used as suggestions for successful installation.

USING CORROSION-RESISTANT FASTENERS AND PL PREMIUM ADHESIVE

Always use corrosion-resistant mechanical fasteners (nails or screws) and PL Premium Adhesive when installing Fypon products. This combination provides a secure, long lasting bond. Countersink all fasteners about 1/8 inch and fill with exterior grade white spackle. If desired, sand any minor imperfections and topcoat with a quality exterior latex or oil base paint. Fypon exterior millwork installations should be finished using a quality, exterior grade silicone caulk to prevent water infiltration behind siding, windows and doors. Some exterior millwork installations, in particular new construction (before siding is applied) may require a J-channel and/or flashing to prevent water infiltration. Installers must determine which installation technique is best for the specific situation.

IMPORTANT:

Please read these installation guidelines thoroughly before beginning installation. Please note that these guidelines are provided only to assist with the installation of Fypon mouldings and millwork products. Modified procedures may be required in order to meet specific situations, unique applications and local building codes. The manufacturer does not under any circumstances warrant the installation of its products. Be sure to wear appropriate protective clothing, gloves and safety glasses when working with any tools. Installer should check for and relocate all electrical wiring within the proposed installation area, as needed (be sure to disconnect all electric power before working with any electrical wiring and follow all applicable local electrical codes and safety procedures).

Structural Column

TIP: Be sure to verify load-bearing capacity of any structural element of the project before ordering to ensure that each component meets specific requirements.

INSTALLATION INSTRUCTIONS

MATERIALS NEEDED

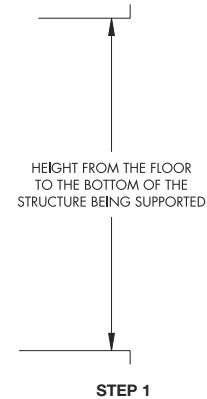

KIT INCLUDES:

Two (2) Column Mounting Plates and Four (4) #14 x 2" Stainless Steel Sheet Metal Screws

STEP 1

Once the location of the column has been determined, carefully measure, at that location, the height from the floor to the bottom of the structure being supported.

STEP 2

Transfer the measurement from Step 1 to the column by placing the tape measure end at the top of the column and marking the bottom (plinth block or base) end of the column. Using this mark and a combination square, draw a line on all four sides of the bottom end of the column. These lines will be used as a guide for cutting the column to length.

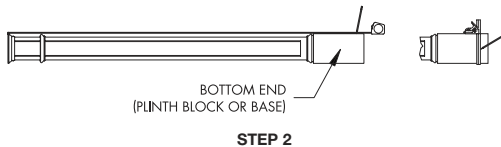

STEP 3

Using the lines drawn in Step 2, cut the urethane shell only using a circular saw or hand saw making sure not to cut into the steel tubing. Use a hacksaw or reciprocating saw with a steel cutting blade to cut through the steel tubing at the same location the urethane shell was cut. Paint all exposed steel at both ends of the column using a quality zinc base primer spray paint (Rust-Oleum® etc.) to help prevent corrosion.

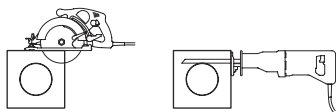

STEP 4

Use a 13/64" drill bit and power drill to drill a hole that is 3/4" up from the bottom of the column and centered on one side. This hole should go through both the urethane shell and steel tubing. Drill another hole on the opposite side of the first hole 3/4" up from the bottom and centered on that side. Again go through both the urethane shell and steel tubing. Using the 13/64" holes as a guide, drill a 1/2" hole through the urethane only on both sides (do not drill through the steel tubing). These 1/2" holes allow the screw to be tightened down to the steel tubing. Repeat this process at the top of the column.

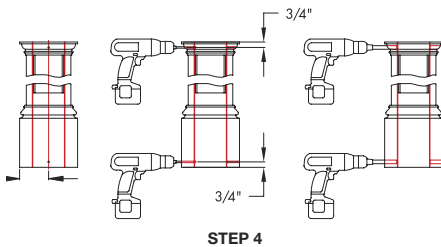

- Ladder
- Tape Measure
- Hacksaw or Reciprocating Saw
- Exterior Spackling (Dap Fast and Final Exterior Spackling or comparable)
- Pencil
- Safety Glasses
- Sandpaper
- Corrosion Resistant Wood or Concrete Fasteners
- Paint Brush
- Latex or Oil Base Paint
- Circular or Hand Saw
- 13/64" Drill Bit
- 1/2" Drill Bit
- Power Drill
- Plumb Bob
- Hydraulic Jack
- Phillips Head Driver
- Combination Square
- Spray Paint

INSTALLATION INSTRUCTIONS CONTINUED ON FOLLOWING PAGE.

USING CORROSION-RESISTANT FASTENERS AND PL PREMIUM ADHESIVE

Always use corrosion-resistant mechanical fasteners (nails or screws) and PL Premium Adhesive when installing Fypon products. This combination provides a secure, long lasting bond. Countersink all fasteners about 1/8 inch and fill with exterior grade white spackle. If desired, sand any minor imperfections and topcoat with a quality exterior latex or oil base paint. Fypon exterior millwork installations should be finished using a quality, exterior grade silicone caulk to prevent water infiltration behind siding, windows and doors. Some exterior millwork installations, in particular new construction (before siding is applied) may require a J-channel and/or flashing to prevent water infiltration. Installers must determine which installation technique is best for the specific situation.

IMPORTANT:

Please read these installation guidelines thoroughly before beginning installation. Please note that these guidelines are provided only to assist with the installation of Fypon mouldings and millwork products. Modified procedures may be required in order to meet specific situations, unique applications and local building codes. The manufacturer does not under any circumstances warrant the installation of its products. Be sure to wear appropriate protective clothing, gloves and safety glasses when working with any tools. Installer should check for and relocate all electrical wiring within the proposed installation area, as needed (be sure to disconnect all electric power before working with any electrical wiring and follow all applicable local electrical codes and safety procedures).

Structural Column (continued)

TIP: Be sure to verify load-bearing capacity of any structural element of the project before ordering to ensure that each component meets specific requirements.

INSTALLATION INSTRUCTIONS

MATERIALS NEEDED

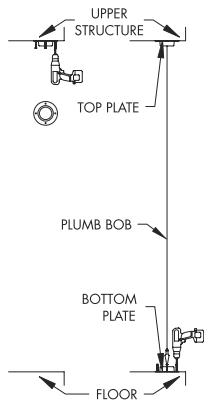

STEP 5

STEP 5

Mount the column mounting plates, at the location determined in Step 1, to the floor and structure to be supported. The plate that is to be mounted to the structure to be supported (the top plate) should be attached first. Use four (4) corrosion resistant fasteners suitable for the mounting application to attach the plate. Use a plumb bob dropped from the center of the top plate to accurately locate the center of the plate to be mounted on the floor (the bottom plate). Again use four (4) corrosion resistant fasteners suitable for the mounting application to attach the plate.

STEP 6

Position the bottle jack and a properly cut to length 2X4 or 4X4 at a location to allow safe lifting of the upper structure. Raise the jack enough to keep the 2X4 or 4X4 in place. Set the column bottom end into place above the bottom plate and begin to lift the upper structure just high enough to allow the column to be swung into place. Once the column is centered with the top plate, slowly lower the jack allowing the upper structure to rest on the column. The bottle jack and 2X4 or 4X4 may now be removed.

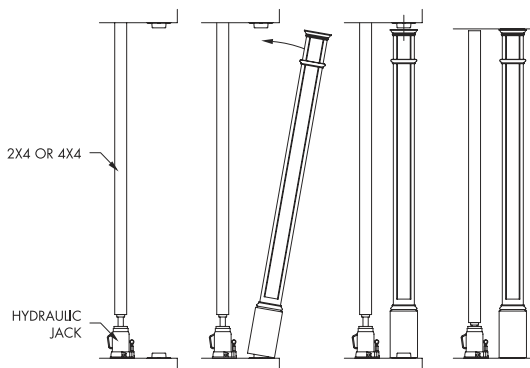

STEP 6

STEP 7

Drill 13/64" holes through the top and bottom column mounting plates using a 13/64" drill bit and the 13/64" holes drilled in Step 3 as guide holes. A total of four holes should be drilled. Attach the column to the column mounting plates using the four (4) #14 x 2" Stainless Steel Sheet Metal Screws (two for the top and two for the bottom) provided in the kit. The screws should be driven so that the heads are flush against the steel tubing.

STEP 8

Patch the screw holes and any blemishes using a quality exterior spackling (Dap Fast'N Final Exterior Spackling or comparable). Once the spackling has dried (no sanding required) paint the column as desired using a quality exterior grade latex or oil base paint.

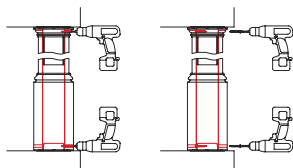

STEP 7

Ladder
Tape Measure
Hacksaw or Reciprocating Saw
Exterior Spackling (Dap Fast and Final Exterior Spackling or comparable)
Pencil
Safety Glasses
Sandpaper
Corrosion Resistant Wood or Concrete Fasteners
Paint Brush
Latex or Oil Base Paint
Circular or Hand Saw
13/64" Drill Bit
1/2" Drill Bit
Power Drill
Plumb Bob
Hydraulic Jack
Phillips Head Driver
Combination Square
Spray Paint

USING CORROSION-RESISTANT FASTENERS AND PL PREMIUM ADHESIVE

Always use corrosion-resistant mechanical fasteners (nails or screws) and PL Premium Adhesive when installing Fypon products. This combination provides a secure, long lasting bond. Countersink all fasteners about 1/8 inch and fill with exterior grade white spackle. If desired, sand any minor imperfections and topcoat with a quality exterior latex or oil base paint. Fypon exterior millwork installations should be finished using a quality, exterior grade silicone caulk to prevent water infiltration behind siding, windows and doors. Some exterior millwork installations, in particular new construction (before siding is applied) may require a J-channel and/or flashing to prevent water infiltration. Installers must determine which installation technique is best for the specific situation.

IMPORTANT:

Please read these installation guidelines thoroughly before beginning installation. Please note that these guidelines are provided only to assist with the installation of Fypon mouldings and millwork products. Modified procedures may be required in order to meet specific situations, unique applications and local building codes. The manufacturer does not under any circumstances warrant the installation of its products. Be sure to wear appropriate protective clothing, gloves and safety glasses when working with any tools. Installer should check for and relocate all electrical wiring within the proposed installation area, as needed (be sure to disconnect all electric power before working with any electrical wiring and follow all applicable local electrical codes and safety procedures).

Glossary

FYPON GENERAL TERMS

ACORN – A piece of decorative millwork that complements an acorn pediment and looks similar to what the name implies, an acorn. Comes in half round and full round styles.

ACORN PEDIMENT – (See Pediment) Triangle shaped “broken” pediment with a semiround center and an acorn ornament. Stacks on top of a door crosshead that usually crosses the top of a doorway.

ADHESIVE - Substance capable of holding material together by surface attachment; it is a general term and includes many adhesives inclusive of “glue.” (See PL Premium Adhesive.)

APPLIQUE - Highly detailed ornamentation that can accent a wall or ceiling application. Looks like sculptured plaster.

ARCH END CAP – A divider or spline accent that separates the arch mould and the straight linear moulding.

ARCH MOULDING – Preformed half round arch that surrounds half round windows, half round sunburst or half round spoked pediments. Flat arch moulding consists of a flat profile. Decorative arch moulding consists of a shaped profile. All arches have a full complement of straight linear mouldings to match.

ARCH PILASTER – (See Pilaster) Profile matches profile of arches available. Use in conjunction with arch as a vertical door/window casing.

ART DECO – Style of decorative art of 1920’s and 1930’s marked by use of geometric designs and bright colors.

BALL – Rounded profile ornaments used primarily for topping posts. (Decorative styles include acorns, urns and pineapples.) (See Finial)

BALUSTER (SPINDLE) – Vertical part used to span an open area between railing and floor or tread, helping to support the railing.

BALUSTRADE – A barrier system which includes handrails, newels and balusters.

BARRIER COAT – First coat of protective paint surface that acts as a mould release and also forms the moulded-in protective skin of the finished urethane product. The barrier coat also prepares the urethane foam part to accept a paint finish.

BASE - Moulding applied around the perimeter of a room at the point of intersection of the wall and finish floor; base shoe is generally used with it, forming a two member base; (also known as baseboard, mopboard and skirting).

BEAD – Semicircular or rounded profile; also a small moulding to secure glass or panels to a door, hence “glass bead.”

BEAD AND COVE – Combination of a “bead” and a “cove” profile.

BONDO (BRAND NAME) – Automotive type filler putty used to patch and cover countersunk fastener holes, seams and damaged urethane foam products. Tends to work better than wood filler putty due to the elastic properties of the Bondo material.

BOTTOM TRIM (BT) – Trim moulding accessory that can be added to the bottom of a door or window crosshead to create a taller crosshead with more detail.

BRACKET – Primarily decorative exterior uses include porches, cornices and part of gable end decoration. Interior applications support or hide joint between beam and wall, embellishments for doorways, supports for shelving and hanging objects.

BREASTBOARD – Lower flat area of a door/window crosshead. Part number refers to the breastboard dimension width when selecting a particular width.

BREASTBOARD DIMENSION – Measurement in inches of the breastboard width. Part number of door/window crossheads refers to this dimension width.

BRICKMOULD – Moulding of window and exterior door frames that abuts the exterior facing material of the structure; serves as the boundary moulding for brick or other siding material.

CAP – Upper member of an entrance, wainscot, partition or pilaster; (also cap trim, wainscot cap, dado moulding, chair rail cap); top portion, above the fluted area, of a pilaster (also capital).

CAST MOULDING – Manufacturing process by which a product can be duplicated many times over from an original master.

CAULKING – Compound for filling joints to prevent leakage of water and air. Weatherproof caulking is made of a silicone base.

CEILING MEDALLION – Plaster-like ornamental round ceiling accent, sometimes used as a trim collar for ceiling fans or hanging lights. Can be used in a sequence to create intersecting ceiling and wall designs.

CHAIR RAIL – Part of a family of moulding used to define the lower section of the wall, and to protect the wall from being scraped by furniture. When used in conjunction with paneling or wainscoting, the rail serves as an ornamental cap.

COLONIAL – Pertaining to the style of architecture and ornamentation of the British Colonies in America in the 17th and 18th centuries. Attributes are well proportioned, formal composition, robust ornamentation, and wood trim vigorously carved to produce pleasant shadows.

COLUMN – Supporting or decorative pillar used in building.

COMBINATION UNIT – Various styles of pediment and crosshead combinations available moulded as one piece for faster installation. Combination units have a slightly smaller projection dimension than a two-piece pediment assembly.

CORBEL – A particularly massive bracket.

CORNER STRIP MOULDING – Mouldings to be used together to make an adjustable outside – maximum 45 degrees. Ideal to trim bay or bow windows.

CORNICE (CORNICE MOULDINGS) – Prominent horizontal projection moulding that crowns the wall of a building. Moulding such as crown, bead and cove applied to cornice construction.

COUNTERSINK – Area where a fastener is recessed below the surface of the millwork.

GLOSSARY CONTINUED ON FOLLOWING PAGE.

Glossary (continued)

FYPON GENERAL TERMS

COVE MOULDING – Moulding with a concave profile used primarily where two members meet at a right angle; a rounded inside corner; opposite to a bullnose; (also scotia, cavetto, ceiling cornice.)

CROSSHEAD – Decorative form that resembles a lintel used to top a door or window, consisting of a breastboard with crown moulding surrounding the top portion, and moulded together as one piece. Crossheads come in heights from 6" to 18". A variety of accessories can be added to complement the design of a simple crosshead. (Also see Door Crosshead and Window Crosshead.)

CROWN MOULDING – Moulding used on cornice or wherever an interior angle is to be covered. A sprung moulding used where two surfaces meet at an angle; usually applied wherever a larger angle is to be covered; (also cornice moulding.)

CUSTOM DESIGN PRODUCT – Product involving the creation of original patterns and development time. Will be quoted on an individual project basis.

DECORATIVE LOUVER – A non-ventilation louver that is to be used as a decorative building accent. Fypon also manufactures louvers that ventilate. (See Functional Louver)

DENSITY – Weight of a substance per unit volume and measured in pounds per cubic foot. Urethane foams can vary for different applications. Fypon building products are at approximately 14 pounds/cubic foot.

DENTIL BLOCK – Smaller rectangle block which can be spaced closely together in a series or in sequence with moulding.

DENTIL MOULDING (DENTIL TRIM) (D) – Series of small square blocks uniformly spaced and projecting like teeth as used in cornice, front entrances and crossheads.

DIVIDER MOULDING BLOCK – A spline accent block that is placed at the seam of a moulding run. Some can also cap the end of a moulding run.

DOOR CASINGS/WINDOW CASINGS – To case in a door or window is to enclose it with a moulding or series of mouldings. They are termed casings and included in the repertoire of most millwork suppliers. Casings range from simple beaded boards to highly complex series of profiles. In addition to mouldings, window or door casing might include such elements as corner blocks, a keystone, and base blocks. (See arches, doorheads, pilasters, door/window moulding.)

DOOR CROSSHEAD – Ornamental form that resembles a lintel, which is a horizontal beam across the top of a door or window. The portion of the entrance above the door opening; (also entrance cap, entablature); commonly used when head is other than a pediment. (See crosshead)

DOOR/WINDOW MOULDING – Trim moulding used as part of door or window casing. Often used in conjunction with a door or window crosshead and rosettes.

DURABILITY – Permanence or resistance to deterioration.

EAVE – Overhanging lower edge of a roof. The margin or lower part of a roof projecting over the wall.

EGG AND DART – Moulding design using an egg and dart alternately. The egg is said to represent life, and the dart death.

ELLIPTICAL – Shaped like an ellipse (which is a closed plane curve that is oval in shape).

E-VENT – Eave vent. A soffit ventilation system which serves a dual purpose combining the attractiveness of a moulding profile and the function of attic ventilation. Installs as one unit.

E-VENT CORNER (INSIDE, OUTSIDE) – Accurate 45° premitered, two-piece corners that match up to straight linear E-Vent mouldings.

E-VENT FILLER BLOCK – Preformed filler block used to give additional support to the E-Vent moulding.

E-VENT JOINING BLOCK/END CAP – Used as a divider spline between linear moulding joints. Protrudes 1/4" from trim profile. Can also cap the end of a linear moulding run.

FABRICATED – Product taken from stock as shown in catalog then cut, sealed and assembled to custom size or design as requested by the customer.

FASCIA MOULDING – Trim moulding applied to fascia board (horizontal facing board just below edge of roof line). A flat board, band or face, used sometimes by itself, but usually in combination with mouldings, often located at outer face of cornice.

FINIAL – Ornament at the top of a gable or sire, or at the end of certain structures. (See ball)

FISHSCALE – Scalloped overlapping shingle style of ornamentation used as façade or gable decoration in late Victorian and Colonial houses.

FLAT TRIM – Moulding that has no decorative profile moulded in. S4S material.

FLUTE – One of the long, parallel, rounded, decorative grooves on the shaft of a pilaster.

FRIEZE BOARD – A decorative, often sculptured, horizontal band along the upper part of a building or a wall in a room. In house construction, a horizontal member connecting the top of the siding with the soffit of the cornice.

FUNCTIONAL LOUVER – A louver with open slats to allow ventilation into the attic area. Fypon functional louvers have a noncorrosive screen backing that also keeps insects out while allowing maximum airflow between the slats. Fypon also manufactures louvers that do not ventilate. (See Decorative Louver)

GABLE PEDIMENT – Decorative millwork used to cover the joint between the gable end of a house and its roof, or simply, gable end ornaments. Take the place of cornice mouldings on exterior of many early-to-mid Victorian houses.

GINGERBREAD – Lavish or superfluous ornamentation especially in architecture.

GLAZING AND FILLER PUTTY – Substance used to fill small imperfections. Used to fill in and smooth the raw edges of the foam.

GLOSSARY CONTINUED ON FOLLOWING PAGE.

Glossary (continued)

FYPON GENERAL TERMS

GOTHIC ARCH – Form of pointed arch over doorway or window from architectural style prevalent in Western Europe from 12th through 15th centuries.

INSIDE MOULDING BLOCK – (See Moulding Block.)

JAMB – Top and two sides of a door or window frame which contact the door or sash; top jamb and side jambs.

JAMB EXTENSION (SUB-JAMB) – Jamb like member, usually surfaced four sides, which increases or extends the width of door frame jamb. Sub-jambs imply a larger width than “jamb liners.” Can be used with window units. (Also extension jamb.)

JAMB LINER – Small strip of wood, either surfaced four sides or tongued on one edge, which, when applied to the inside edge of a window jamb, increases its width.

JAMB REVEAL (FACE OF JAMB) – The exposed surface of a jamb next to the door or window. The margin visible between the window or door jamb and the surrounding trim or casing.

J-CHANNEL – Accessory available through siding manufacturers for installing trim work. J-channels are butted up against the trim work allowing the siding to be cut and fit into these channels.

J-CHANNEL, FLEXIBLE – Used as J-channel; however, the liner is flexible to follow curved shapes.

KEystone – Traditionally topmost member of an arch. Most often appears as part of an entryway surround or window crosshead. Available in three styles including plain, recessed panel and art deco.

LOUVER – A building component installed into the side wall to allow ventilation and/or decoration on a building. Styles may be square, rectangle, triangle, quarter or half round, etc. (See catalog for all styles of louvers.)

LOUVER TRIM – One-piece moulded trim that surrounds various shapes of a louver giving the louver the appearance of a more massive building component.

MASTER – An original from which copies can be made.

MOULDED EDGE – Edge of piece machined to any profile other than square or eased edge.

MOULDING – Ornamental strip used to decorate a surface, often used to accent or emphasize the ornamentation of a structure and to conceal surface or angle joints.

MOULDING BLOCK (INSIDE, OUTSIDE) – A moulded corner system that eliminates the need for difficult angled cuts. Lineal mouldings easily butt up to these preformed corners.

MULL – Term used to join two or more windows at the jamb or door side lights to the door unit. Fypon manufactures fluted mull mouldings to cover the seams where the jambs meet.

NICHE – A wall recess traditionally used to display a sculpture or ornamental object.

NONPENETRATING STAIN – A type of stain formulated to lay on top, and not soak into the open pores, of a surface.

ORDER ACKNOWLEDGMENT – Upon our customer service staff receiving an order via FAX or phone call, Fypon will FAX a confirmation back to our customer that the order has been received, and verify the products ordered.

ORNAMENTS – Useful designation for all those infrequently used, highly decorative wall and ceiling motifs, such as garlands, leaves, scrolls, shells, shields, sunburst, and wreath embellishments. Ball ornaments include urns, acorns, pineapples, etc.

OUTSIDE MOULDING BLOCK – (See Moulding Block.)

PEAKED (PEDIMENT) – Solid triangle pediment head unbroken along its perimeter.

PEDIMENT – Used to describe topmost member of a formal entryway (Pediment stacks above the crosshead) and includes the caps or heads which ornament windows and interior door. Broken Pediment - A pediment broken along its perimeter; not solid; (Acorn Pediment) often contains an acorn in its broken portion; may be scroll-like (Rams Head Pediment). Rounded Pediment - An arc-like “pediment” (Sunburst, Elliptical, Half Round, etc.). Solid Pediment - Triangle head unbroken along its perimeter (Peaked Cap Pediment.)

PILASTER – Vertical column, often ornamental, that projects slightly from the wall. Most are purely decorative. May be rectangle or half round; often has a base (plinth block), shaft (middle section), and capital. Most often used as simulated columns in entryway and other door openings.

PITCH – Incline slope of a roof or the ratio of the total rise to the total width of a house. Roof slope is expressed in the inches of rise per foot of run.

PITCH BLOCK – Thick, massive filler block that can be field trimmed to adjust to various roof pitches.

PL PREMIUM® ADHESIVE – Urethane base construction adhesive that is superior for attaching and joining polyurethane millwork.

PLASTIC WOOD FILLER – (See Bondo, and Glazing and Filler Putty.)

PLINTH BLOCK – Square block at the base of a pilaster; thicker and wider than the abutting members.

POLYURETHANE FOAM – Mixture of two resins that create a chemical foaming reaction. Polyurethane foam (or urethane) is the component of Fypon products. Once cast and removed from the mould it is difficult to differentiate from wood or plaster components. Characteristics of the finished product include resistance to rotting, splitting, warping, paint peeling, chipping and insects.

PRIME COAT FINISH (PRIMER) – A paint finish intended for a later application of paint. The first coat of paint in an application that consists of two or more coats.

PROJECTION – Thrust outward, protrude. The distance the millwork protrudes away from a surface.

QUARTER ROUND LOUVER – (See Louver) Available in left and right hand configurations.

GLOSSARY CONTINUED ON FOLLOWING PAGE.

Glossary (continued)

FYPON GENERAL TERMS

QUOIN – Decoration forming an exterior outside corner (stone look) to a building.

RAILING – Horizontal bar supported at both ends or at intervals by posts, as in a balustrade, and used as a barrier.

RAMS HEAD (PEDIMENT) – Scroll-like broken pediment with an urn in its open portion.

ROSETTE – A square block with a circular decorative design in the center usually used as a corner block as part of the casing around windows and doors.

RTV SILICONE MOULD – The production mould from which the actual urethane building products are moulded or cast.

SCALLOP – One of a series of curves, shaped like semicircles, that form a border.

SCONCE – A decorative wall bracket for candles or electric lights.

SHOE MOULDING – Quarter round trim applied at the bottom of baseboard where it meets the floor.

SILL MOULDING – Moulding designed to resist or shed water away from a wall surface.

SOFFIT – Usually the underside of an overhanging cornice.

SPANDREL – Decorative type of spindle system that covers the distance between columns and posts.

STANDARD MILLWORK – All product shown in the catalog.

SUNBURST – A half round or segmented area, the lower center of which contains a sun-like figure with fanned sun rays radiating therefrom.

TRIM – The finish materials in a building, such as mouldings, applied around openings (window trim, door trim) or at the floor and ceiling of rooms (baseboard, cornice and other mouldings.)

TRIM STRIP (T) – A decorative accessory that can be added to the breastboard of the crosshead to create a more detailed appearance.

UNDERSILL TRIM – Accessory available through siding manufacturers for installing trim work. Undersill trim is a thinner type of J-Channel that allows the siding to be cut and fit into the undersill channel.

URETHANE FOAM – (See Polyurethane Foam)

UV STABLE – Ultraviolet sunlight stable. Sun rays will not affect the quality of the product.

VENT (VENTILATION) – Provides an opening for the circulation (or passage) of fresh air.

VICTORIAN – Name assigned to the style of architecture prominent in the United States during the period 1860-1893.

WAINSCOTING – A lower interior wall surface that contrasts with the wall surface above it. An interior wall composed of two different interior wall surfaces, one above the other.

WINDOW CROSSHEAD – An ornamental form that resembles a lintel, which is a horizontal beam across the top of a door or window.

WINDOW PANEL – Decorative raised panel placed directly below a window. Other applications include placement in a series creating a wainscoting system, or around the front of a whirlpool tub to act as water resistant, decorating access panels.

WINDOW PEDIMENT – (See Pediment).

WOODGRAIN/STAINABLE – Special moulded-in texture on the surface of urethane millwork resembling oak, redwood or cedar. Product will accept nonpenetrating stain or paint.

WREATH AND BOW – Large decorative wreath-shaped building accent usually placed on the gable end of a traditional building.