

Column Wraps



- NEW** Structural Post205
- NEW** EverCedar Flat-Pack
Square Column Wraps207
- NEW** EverCedar Flat-Pack
Tapered Column Wraps208
- ProSelect PVC Smooth
Square Column Wraps210
- NEW** ProSelect PVC Flat-Pack
Square Column Wraps211
- PremiumSelect
Square Column Wraps213
- NEW** PremiumSelect Flat-Pack
Square Column Wraps214
- Square Cap & Base
Accessories215
- PremiumSelect Tapered
Column Wraps216
- NEW** PremiumSelect Flat-Pack
Tapered Column Wraps218
- Tapered Cap & Base
Accessories.....219

COVERAGE WITH CHARACTER.

Once you've met the structural requirements of your project, Fypon® Column Wraps can be used to add an elegant finishing touch. Designed for easy installation around an existing structural support, column wraps are perfect for adding character to a new job or covering an outdated design.

Product Shown:
EverCedar Wood-Grained Flat-Pack Square Column Wraps
Wood-Grained Flat Trim



Column Wraps

HOW TO ORDER

Column Wraps

Fypon® Column Wraps are non-structural and designed to wrap around an existing treated wood post or other structural support. Square and tapered styles are available in a variety of heights and are trimmable from the bottom of the shaft up to 3". Flat-panel column wraps can be trimmed to any height.

PremiumSelect Column Wraps come in a complete kit that includes shaft, cap, base, installation cleat, hardware, tube of adhesive and installation materials. Installation kits for ProSelect Column Wraps are sold separately.

New flat-pack column wraps ship unassembled for better handling and utilization of less storage space. Choose from square and tapered styles in smooth PVC or wood-grained polyurethane.

Column Wrap Accessories

Square column wraps come semi-assembled and include a Traditional cap and base, and tapered column wraps come semi-assembled and include a Craftsman cap and base. Six additional cap and base styles are available and can be ordered separately. Caps and bases ship in four separate pieces with pre-mitered corners.

Special Order Products

PremiumSelect products shown in the catalog are available in additional sizes. Product may be modified to minimum 6" width to a 24" maximum width. The height may also be modified with a minimum height of 48" to a maximum of 144" height (maximum 108" for tapered).



FLEXIBLE POSITIONING COLUMN WRAPS

The design features installation cleats on the interior or exterior of the shaft providing ample room around the support post. This allows for positioning adjustments to align several columns in a row or to allow for positioning close to the porch edge. Also, because the column wrap does not come in contact with the structural post, the integrity of the wrap is not dependent on the support.

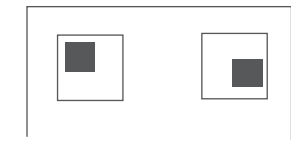

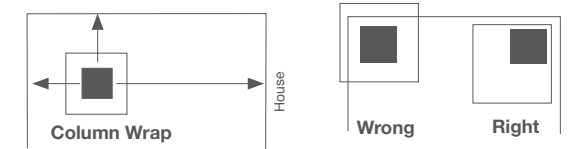

Flexible positioning around support post.

Before you order, you'll want to measure to make sure you have enough clear distance from the support post to the edge of the porch. The needed space is dependent on the style of column. You will need more space for tapered columns than square due to the larger base.



Allow adequate distance when choosing wrap width.

Accessories

Description	Height	Part Number
 <p>Installation Kit includes adhesive and screw pack.</p>	—	CWINSTALLKIT
 <p>NEW Aluminum Structural Post with a load-bearing capacity of 5,000 lbs.* Kit includes aluminum post, 4x4 post mount and screws.</p>	96" 108" 120"	STRPOSTKIT96 STRPOSTKIT108 STRPOSTKIT120

*Average ultimate wind uplift resistance of 1200 lbs.
Note: Always consult the local building code authority to determine suitability of products to meet specific project requirements. Parts may be required to ship LTL (less than truckload) based on size and overall dimensions.



EverCedar Wood-Grained Flat-Pack Square Column Wraps

Unassembled with Standard Cap & Base

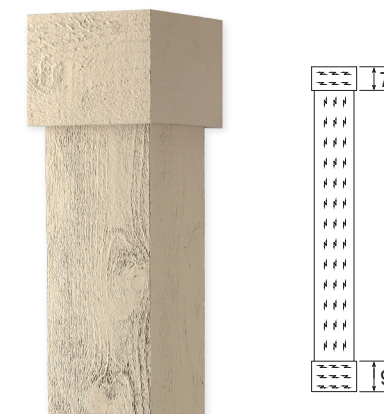

Shaft Width	Height	Flat Panel (FT)
6" (5-3/4" Actual)	8' (96")	CWEVFLT6X96SFT
	9' (108")	CWEVFLT6X108SFT
	10' (120")	CWEVFLT6X120SFT
4-1/4" Actual Inside Width		
8" (7-3/4" Actual)	8' (96")	CWEVFLT8X96SFT
	9' (108")	CWEVFLT8X108SFT
	10' (120")	CWEVFLT8X120SFT
6-1/4" Actual Inside Width		
10" (9-3/4" Actual)	8' (96")	CWEVFLT10X96SFT
	9' (108")	CWEVFLT10X108SFT
	10' (120")	CWEVFLT12X120SFT
8-1/4" Actual Inside Width		
12" (11-3/4" Actual)	8' (96")	CWEVFLT12X96SFT
	9' (108")	CWEVFLT12X108SFT
	10' (120")	CWEVFLT12X108SFT
10-1/4" Actual Inside Width		

Square Cap & Base Accessories

	6" x 6"	8" x 8"	10" x 10"	12" x 12"
	CWCB6EV	CWCB8EV	CWCB10EV	CWCB12EV
	Ships standard with all EverCedar Square Column Wrap Kits.			

Parts may be required to ship LTL (less than truckload) based on size and overall dimensions.

NEW

EverCedar Wood-Grained Flat-Pack Tapered Column Wraps

Unassembled with Standard Cap & Base

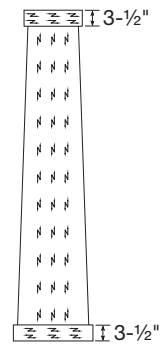

Shaft Width	Height	Flat
8" Top (7-3/4" Actual)	4' (48")	CWEVFLT8X12X48TFT
	4-1/2' (54")	CWEVFLT8X12X54TFT
	5' (60")	CWEVFLT8X12X60TFT
	5-1/2' (66")	CWEVFLT8X12X66TFT
12" Bottom (11-3/4" Actual)	6' (72")	CWEVFLT8X12X72TFT
	8' (96")	CWEVFLT8X12X96TFT
	4' (48")	CWEVFLT11X16X48TFT
	4-1/2' (54")	CWEVFLT11X16X54TFT
11" Top (10-3/4" Actual)	5' (60")	CWEVFLT11X16X60TFT
	5-1/2' (66")	CWEVFLT11X16X66TFT
	6' (72")	CWEVFLT11X16X72TFT
16" Bottom (15-3/4" Actual)	8' (96")	CWEVFLT11X16X96TFT

Tapered Cap & Base Accessories

	8" x 12"	11" x 16"
	CWCB8X12EV48-60*	CWCB11X16EV48-60*
	CWCB8X12EV66-96**	CWCB11X16EV66-96**
Ships standard with all EverCedar Tapered Column Wrap Kits.		

*Cap and base size for tapered column wraps 48-60" in height.
 **Cap and base size for tapered column wraps 66-96" in height.
 Parts may be required to ship LTL (less than truckload) based on size and overall dimensions.



ProSelect Square Column Wraps

Semi-Assembled PVC Flat Panel with Plain Cap & Base

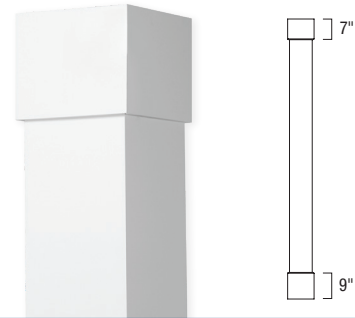

Shaft Width	Height	Flat Panel (FT)
6" (5-3/4" Actual) 4" Actual Inside Width	6' (72")	CWPR6X72SFT
	8' (96")	CWPR6X96SFT
	9' (108")	CWPR6X108SFT
	10' (120")	CWPR6X120SFT
	12' (144")	CWPR6X144SFT
8" (7-3/4" Actual) 4-7/8" Actual Inside Width	6' (72")	CWPR8X72SFT
	8' (96")	CWPR8X96SFT
	9' (108")	CWPR8X108SFT
	10' (120")	CWPR8X120SFT
	12' (144")	CWPR8X144SFT
10" (9-3/4" Actual) 6-7/8" Actual Inside Width	6' (72")	CWPR10X72SFT
	8' (96")	CWPR10X96SFT
	9' (108")	CWPR10X108SFT
	10' (120")	CWPR10X120SFT
	12' (144")	CWPR10X144SFT
12" (11-3/4" Actual) 8-7/8" Actual Inside Width	6' (72")	CWPR12X72SFT
	8' (96")	CWPR12X96SFT
	9' (108")	CWPR12X108SFT
	10' (120")	CWPR12X120SFT
	12' (144")	CWPR12X144SFT

ProSelect Flat-Pack Square Column Wraps

Unassembled PVC Shaft (cap and base sold separately)

Features

- ProSelect square column shaft features a flat-panel style.
- Accessories are sold separately, allowing you to create a custom look. See page 215 for additional options.
- Interior cleat included for easy installation.
- Installation materials sold separately. See page 205.
- Product ships flat for easy handling and storage.
- Optional Structural Post Kit has a load-bearing capacity of up to 5000 lbs. and an average wind uplift resistance of 1200 lbs.



Shaft Width	Height	Flat Panel (FT)
6" (5-3/4" Actual)	8' (96")	CWPRFLT6X6X96SFT
	9' (108")	CWPRFLT6X6X108SFT
4" Actual Inside Width		





PremiumSelect Square Column Wraps

Semi-Assembled with Traditional Cap & Base

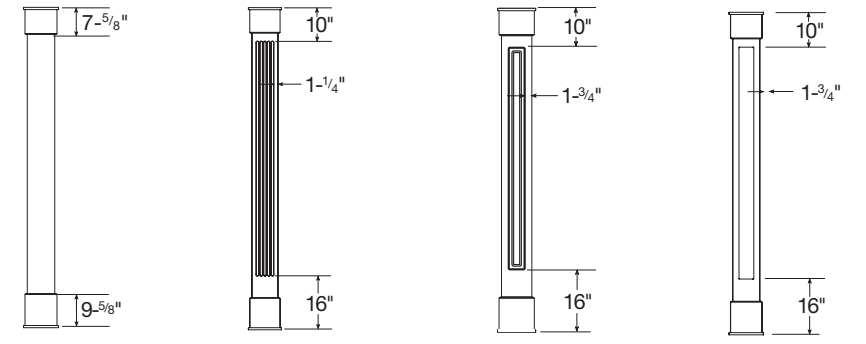

Flutes are 5/8" wide and 1/4" deep. Number and spacing of flutes varies by width of shaft.

Route is 1-11/32" wide by 3/8" deep.

Recess is 1/2" deep and corners are 1/4" rounded.



Shaft Width	Height	Flat Panel (FT)	Fluted (FL)	Raised Panel (RS)	Recessed Panel (RC)
6" (5-3/4" Actual)	6' (72")	CWPM6X72SFT	—	—	—
	8' (96")	CWPM6X96SFT	—	—	—
	9' (108")	CWPM6X108SFT	—	—	—
	10' (120")	CWPM6X120SFT	—	—	—
	12' (144")	CWPM6X144SFT	—	—	—
4-3/4" Actual Inside Width					
8" (7-3/4" Actual)	6' (72")	CWPM8X72SFT	CWPM8X72SFL	CWPM8X72SRS	CWPM8X72SRC
	8' (96")	CWPM8X96SFT	CWPM8X96SFL	CWPM8X96SRS	CWPM8X96SRC
	9' (108")	CWPM8X108SFT	CWPM8X108SFL	CWPM8X108SRS	CWPM8X108SRC
	10' (120")	CWPM8X120SFT	CWPM8X120SFL	CWPM8X120SRS	CWPM8X120SRC
	12' (144")	CWPM8X144SFT	CWPM8X144SFL	CWPM8X144SRS	CWPM8X144SRC
6-3/4" Actual Inside Width				5-3/4" Actual Inside Width	
10" (9-3/4" Actual)	6' (72")	CWPM10X72SFT	CWPM10X72SFL	CWPM10X72SRS	CWPM10X72SRC
	8' (96")	CWPM10X96SFT	CWPM10X96SFL	CWPM10X96SRS	CWPM10X96SRC
	9' (108")	CWPM10X108SFT	CWPM10X108SFL	CWPM10X108SRS	CWPM10X108SRC
	10' (120")	CWPM10X120SFT	CWPM10X120SFL	CWPM10X120SRS	CWPM10X120SRC
	12' (144")	CWPM10X144SFT	CWPM10X144SFL	CWPM10X144SRS	CWPM10X144SRC
8-3/4" Actual Inside Width				7-3/4" Actual Inside Width	
12" (11-3/4" Actual)	6' (72")	CWPM12X72SFT	CWPM12X72SFL	CWPM12X72SRS	CWPM12X72SRC
	8' (96")	CWPM12X96SFT	CWPM12X96SFL	CWPM12X96SRS	CWPM12X96SRC
	9' (108")	CWPM12X108SFT	CWPM12X108SFL	CWPM12X108SRS	CWPM12X108SRC
	10' (120")	CWPM12X120SFT	CWPM12X120SFL	CWPM12X120SRS	CWPM12X120SRC
	12' (144")	CWPM12X144SFT	CWPM12X144SFL	CWPM12X144SRS	CWPM12X144SRC
10-3/4" Actual Inside Width				9-3/4" Actual Inside Width	

Note: Installation cleats ship with column wrap and are applied on the exterior shaft. Parts may be required to ship LTL (less than truckload) based on size and overall dimensions.

PremiumSelect Flat-Pack Square Column Wraps

Unassembled PVC Shaft (cap and base sold separately)

Features

- PremiumSelect square column shaft features a flat-panel style.
- Accessories are sold separately, allowing you to create a custom look. See page 215 for additional options.
- Exterior cleat included for easy installation.
- Installation materials sold separately.
- Product ships flat for easy handling and storage.
- Optional Structural Post Kit has a load-bearing capacity of up to 5000 lbs. and an average wind uplift resistance of 1200 lbs.



Shaft Width	Height	Flat Panel (FT)
6" (5-3/4" Actual)	9' (108")	CWPMFLT6X6X108SFT
	10' (120")	CWPMFLT6X6X120SFT
4-3/4" Actual Inside Width		
8" (7-3/4" Actual)	8' (96")	CWPMFLT8X8X96SFT
	9' (108")	CWPMFLT8X8X108SFT
	10' (120")	CWPMFLT8X8X120SFT
6-3/4" Actual Inside Width		
10" (9-3/4" Actual)	8' (96")	CWPMFLT10X10X96SFT
	9' (108")	CWPMFLT10X10X108SFT
	10' (120")	CWPMFLT10X10X120SFT
8-3/4" Actual Inside Width		



Square Cap & Base Accessories

Style		6" x 6"	8" x 8"	10" x 10"	12" x 12"
Traditional		CWCB6TR	CWCB8TR	CWCB10TR	CWCB12TR
		Ships standard with the semi-assembled PremiumSelect Square Column Wrap Kits.			
Craftsman		CWCB6CF	CWCB8CF	CWCB10CF	CWCB12CF
Greek		CWCB6GK	CWCB8GK	CWCB10GK	CWCB12GK
Plain		CWCB6PL	CWCB8PL	CWCB10PL	CWCB12PL
		Ships standard with the semi-assembled ProSelect Square Column Wrap Kits.			
Roman		CWCB6RO	CWCB8RO	CWCB10RO	CWCB12RO
Tuscan		CWCB6TS	CWCB8TS	CWCB10TS	CWCB12TS
		Tuscan cap and base are high-density polyurethane.			
Neck Mould		CW6NM	CW8NM	CW10NM	CW12NM

PremiumSelect Tapered Column Wraps

Semi-Assembled with Craftsman Cap & Base

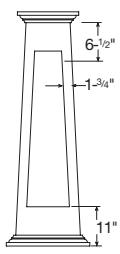
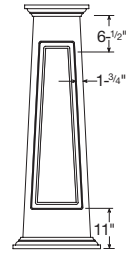
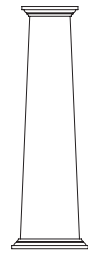

Route is 1-3/8" wide by 3/8" deep.

Recess is 1/2" deep and corners are 1/4" rounded.



Shaft Width	Height	Flat	Raised Panel	Recessed Panel
8" Top (7-3/4" Actual)	4' (48")	CWPM8X12X48TFT	CWPM8X12X48TRS	CWPM8X12X48TRC
	4-1/2' (54")	CWPM8X12X54TFT	CWPM8X12X54TRS	CWPM8X12X54TRC
	5' (60")	CWPM8X12X60TFT	CWPM8X12X60TRS	CWPM8X12X60TRC
12" Bottom (11-3/4" Actual)	5-1/2' (66")	CWPM8X12X66TFT	CWPM8X12X66TRS	CWPM8X12X66TRC
	6' (72")	CWPM8X12X72TFT	CWPM8X12X72TRS	CWPM8X12X72TRC
	8' (96")	CWPM8X12X96TFT	CWPM8X12X96TRS	CWPM8X12X96TRC
11" Top (10-3/4" Actual)	4' (48")	CWPM11X16X48TFT	CWPM11X16X48TRS	CWPM11X16X48TRC
	4-1/2' (54")	CWPM11X16X54TFT	CWPM11X16X54TRS	CWPM11X16X54TRC
	5' (60")	CWPM11X16X60TFT	CWPM11X16X60TRS	CWPM11X16X60TRC
16" Bottom (15-3/4" Actual)	5-1/2' (66")	CWPM11X16X66TFT	CWPM11X16X66TRS	CWPM11X16X66TRC
	6' (72")	CWPM11X16X72TFT	CWPM11X16X72TRS	CWPM11X16X72TRC
	8' (96")	CWPM11X16X96TFT	CWPM11X16X96TRS	CWPM11X16X96TRC
13" Top (12-3/4" Actual)	4' (48")	CWPM13X20X48TFT	CWPM13X20X48TRS	CWPM13X20X48TRC
	4-1/2' (54")	CWPM13X20X54TFT	CWPM13X20X54TRS	CWPM13X20X54TRC
	5' (60")	CWPM13X20X60TFT	CWPM13X20X60TRS	CWPM13X20X60TRC
20" Bottom (19-3/4" Actual)	5-1/2' (66")	CWPM13X20X66TFT	CWPM13X20X66TRS	CWPM13X20X66TRC
	6' (72")	CWPM13X20X72TFT	CWPM13X20X72TRS	CWPM13X20X72TRC
	8' (96")	CWPM13X20X96TFT	CWPM13X20X96TRS	CWPM13X20X96TRC
16" Top (15-3/4" Actual)	4' (48")	CWPM16X24X48TFT	CWPM16X24X48TRS	CWPM16X24X48TRC
	4-1/2' (54")	CWPM16X24X54TFT	CWPM16X24X54TRS	CWPM16X24X54TRC
	5' (60")	CWPM16X24X60TFT	CWPM16X24X60TRS	CWPM16X24X60TRC
24" Bottom (23-3/4" Actual)	5-1/2' (66")	CWPM16X24X66TFT	CWPM16X24X66TRS	CWPM16X24X66TRC
	6' (72")	CWPM16X24X72TFT	CWPM16X24X72TRS	CWPM16X24X72TRC
	8' (96")	CWPM16X24X96TFT	CWPM16X24X96TRS	CWPM16X24X96TRC

Note: Installation cleats ship with column wrap and are applied on the exterior shaft.
Parts may be required to ship LTL (less than truckload) based on size and overall dimensions.



NEW

PremiumSelect Flat-Pack Tapered Column Wraps

Unassembled PVC Shaft (cap and base sold separately)

Features

- PremiumSelect tapered style features a flat-panel shaft.
- Accessories are sold separately, allowing you to create a custom look. See page 219 for additional options.
- Exterior cleat included for easy installation.
- Product ships flat for easy handling or storage.
- Optional Structural Post Kit has a load-bearing capacity of up to 5000 lbs. and an average wind uplift resistance of 1200 lbs.



Shaft Width	Height	Flat
8" Top (7-3/4" Actual)	5' (60")	CWPMFLT8X12X60TFT
12" Bottom (11-3/4" Actual)	5-1/2' (66")	CWPMFLT8X12X66TFT
	6' (72")	CWPMFLT8X12X72TFT
11" Top (10-3/4" Actual)	5' (60")	CWPMFLT11X16X60TFT
16" Bottom (15-3/4" Actual)	5-1/2' (66")	CWPMFLT11X16X66TFT
	6' (72")	CWPMFLT11X16X72TFT

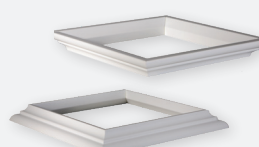
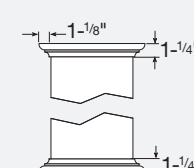
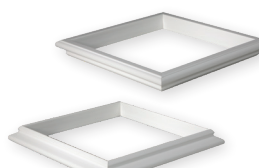
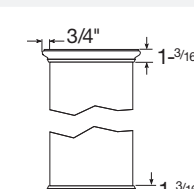
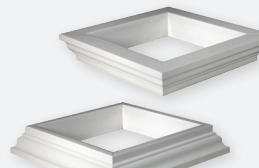
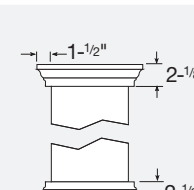
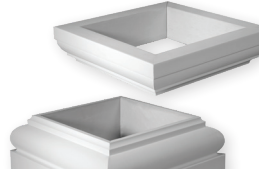
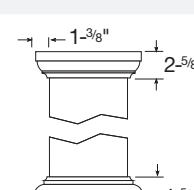
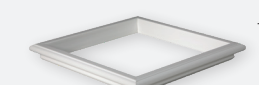
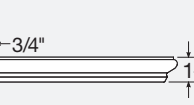

Tapered Cap & Base Accessories

Style	8" x 12"	11" x 16"	13" x 20"	16" x 24"		
Craftsman			CWCB8X12CF	CWCB11X16CF	CWCB13X20CF	CWCB16X24CF
Ships standard with semi-assembled PremiumSelect Tapered Column Wrap Kits.						
Greek			CWCB8X12GK	CWCB11X16GK	CWCB13X20GK	CWCB16X24GK
Roman			CWCB8X12RO	CWCB11X16RO	CWCB13X20RO	CWCB16X24RO
Tuscan			CWCB8X12TS	CWCB11X16TS	CWCB13X20TS	CWCB16X24TS
Tuscan cap and base are high-density polyurethane.						
Neck Mould			CW17NM	Trimmable to fit up to 16" wide top width.		

Column Wraps

Column Wraps